

PAVILION V

ARCHITECTURAL DESCRIPTION

EXTERIOR

Pavilion V is located near the center of the west side of the Lawn. The east facade faces the Lawn; it is five bays wide and two stories tall with a gable roof and a projecting portico. Behind the original 1819-23 pavilion is an addition built circa 1850. The addition is two stories and basement high, two bays deep, and two bays wide. A hyphen, built circa 1850 and subsequently modified between 1850 and 1903/1929, connects the two buildings; the hyphen is two stories and a basement high, three bays deep, and three bays wide. The exterior modifications and additions made to the hyphen and the rear wing are physically very evident. Differences in detailing and in paint layering indicate that this work was not carried out in a single building campaign. The work was likely undertaken in 1903, when the Pavilion was jointly occupied by Professors Smith and Kent, and in 1929 when Professors Wilson and Sparrow occupied the structure. Unfortunately, no documentary evidence was uncovered that would reveal exactly when the changes were made. In the following description, this work is identified by the dates 1903/1929.

Pavilion V and Pavilion I were similarly modified circa 1850 when large brick additions were appended to the backs of the original structures. At Pavilion I the addition was attached across the rear facade of the basement and first story, resulting in the loss of the rear windows of the original lower part of the pavilion. At Pavilion V, a massive two-story and basement addition was constructed approximately 16 feet west of the original building and joined to it by a narrow enclosed connector or hyphen. This configuration left the original rear windows of the pavilion exposed. Only much later, when the hyphen was enlarged, was the sense of separation between the original pavilion and the addition lost.

PAVILION V

Thomas Jefferson designed the portico on the east facade using the "Ionic of Palladio" found in the 1721 Leoni edition of Palladio's *Five Books of Architecture*. The columns have attic bases on plinths, unfluted shafts, and Ionic capitals. The bases and capitals are of stone, and the shafts are of stuccoed brick. The capitals have volutes on the front and back and balusters on the sides. The wooden entablature (4' 5⁷/₈" deep) has a three-fascia architrave, a plain frieze, and a denticulated cornice, which also contains an ovolo ornamented with an egg-and-dart motif.

The wood entablature moldings from the top include the cornice, which has a cymatium with a cyma recta, a fillet, and a cyma reversa; a corona supported by modillions and decorated with lead rosettes applied to the soffit between the modillions; and a bed molding consisting of an ovolo with egg-and-dart ornament and a cavetto. The substrate and the eggs of the egg-and-dart ornament are of carved wood to which delicately cast lead darts are attached. Below a plain frieze, the architrave has a fillet, a cyma reversa, and three fasciae with beads at the bottom edges.

The deep entablature of the portico is carried around the three remaining sides of the original building as a unifying element. Above the entablature there is a hipped slate roof dating to 1837. The original 1819-23 ridge-and-furrow roof remains *in situ* in the attic. The original 1819-23 chimney, located immediately west of the ridge, was extended when the existing roof was constructed and now projects approximately 3' 0" above the peak.

EAST FACADE

The east facade is deeply recessed behind the columns of the portico. The facade is constructed of hand-made red brick, varying slightly in size, laid in Flemish bond with king closers at the window openings and queen closers at the ends. The bricks are 7⁷/₈" to 8" long by 3³/₄" to 3⁷/₈" wide by 2⁵/₈" to 2³/₄" high, with six courses equal to 1' 5¹/₂". The mortar in the narrow joints is recessed along the edges and is nearly even with the face of the brick at the center.

The pavement of the portico on the first story is twentieth-century brick laid in a herringbone pattern with a six-brick-wide border parallel to the facade. Three stone steps lead to the wood threshold of the doorway in the center bay. The steps are 5' 6" wide and approximately 1' 1³/₄" deep. The lowest riser is approximately 6⁷/₈" high, while the upper risers are 8" high; the treads are approximately 1³/₄" thick. The original entrance door and the transom above are set in a 9¹/₂"-deep

ARCHITECTURAL DESCRIPTION

reveal with raised panels corresponding in dimension and placement to those of the door. The paneled reveal, as well as the two-fascia architrave encompassing both the door and the transom ($7\frac{7}{8}$ " wide with two fasciae, a cyma reversa, and a fillet, Type T-1), and the molding between them have recently been sandpainted to resemble stone. The original rectangular transom is divided into eleven lights by delicate semicircular and radiating muntins.

The door is flanked by two-panel blinds supported by original iron strap hinges and iron pintles. The strap hinges are $1' 9\frac{1}{4}$ " long by $1\frac{3}{8}$ " to $1\frac{3}{4}$ " wide. J-shaped holdbacks imbedded in the masonry wall below the blinds are later replacements. The blinds have an original iron swinging bar latch. The north blind has an oval plate ($2\frac{1}{8}$ " wide by $4\frac{1}{2}$ " high by $\frac{1}{8}$ " thick) with a pivot in the center that holds a bar ($1\frac{1}{2}$ " wide and $1' 4\frac{1}{2}$ " long) rounded at the ends. There is a keeper on each blind. Each keeper has a trefoil-shaped base fastened to the blind with three screws and a $\frac{1}{8}$ " thick U-shaped section to hold the bar.

To the north of the entry there are two original small basement windows, partially below grade, facing small wells below the surface of the pavement. The windows are framed by $6\frac{3}{4}$ "-wide two-fascia architraves (Type T-2) and feature later three-light, in-swinging awning sash. The northernmost window has $\frac{7}{8}$ " square wood bars running across the opening. The window wells are protected by sloped wood frames filled with $\frac{1}{2}$ " hardware cloth dating from the twentieth century.

The original windows on the first floor, located in openings as tall as that of the central doorway, have $6\frac{1}{2}$ "-wide two-fascia architraves (Type T-2) at the sides and top and $2\frac{3}{4}$ " thick sills at the bottom. They have 6/6/6 triple-hung sash. All of these elements are original. Paired blinds flank the windows; the blinds are supported by early wrought-iron strap hinges on pintles. Original wrought-iron J-shaped holdbacks are located next to each blind. Seven remain *in situ*, and nine holes are empty. The iron holdbacks at the bottom of the blinds are later additions. Wood "Chinese" railings, similar to those on the east porch, extend across each window; these fittings are recent restorations.

Like the first story, the articulation of the second story of the east facade includes a door in the center bay and two windows at either side, each with two-fascia architraves ($6\frac{1}{2}$ "± wide) (Type T-2). There is a twentieth-century two-panel screen door with two 3" spring hinges. The sides and top of the reveal behind the screen door are paneled. Each of the two leaves of the original door behind (Type D-21) has three panels; the upper two panels are glazed, and the lower panel is raised. The doorway is located three risers above the balcony floor. Each of the wooden

PAVILION V



North facade of Pavilion V

risers is approximately 7" high. The two treads are 1' 1½" deep, with a 1" nosing, and 4' 8" wide. The original windows have 6/6 double-hung sash. The original blinds on either side of the windows are held open with iron replacement holdbacks. The original holdbacks were located at the sides of the blinds in holes positioned in the mortar joint between the twenty-first and twenty-second brick courses above the balcony deck.

The porch, beginning 1' 2⅞" behind the inside face of the columns, is hung from the structure at the attic floor level by five ⅝" diameter wrought-iron rods. The porch has a deck of random-width floorboards running east-west that slopes slightly to the east for drainage and is covered by flat-seam sheet-metal roofing material. The original 2' 11⅜"-high wood rail, including a bottom rail, a top rail (4½" wide by 3¼" high), panels behind the columns, and 1¼" by 2⅞" wood members

ARCHITECTURAL DESCRIPTION

forming triangles, diamonds, and trapezoids between, is located along the south and east edges of the porch. The ceiling of the porch is original random width, tongue-and-groove sheathing, running east-west.

There are two duplex electrical receptacles servicing the porch: one is beneath the south window and the other is set in the wall immediately north of the door.

NORTH FACADE

From the north all three parts of the existing structure are apparent, with the original pavilion to the east, the circa 1850 addition to the west, and the hyphen connecting the two buildings. The north facade of the original 1819-23 pavilion is three bays wide with two stories and a basement. The facade is topped by an entablature surmounted by a hipped, slate shingle roof. Both the basement and the first floor have two windows (to the west of the student dormitory rooms), and the second floor has three windows. All windows in this facade contain 6/6 double-hung sash and are framed by two-fascia architraves at the sides and top; those windows in the basement are shorter (pane size 12" by 14") than those in the upper floors (pane size 12" by 18"). The architrave profiles for the basement windows are Type T-3, and the architrave profiles for the other windows are Type T-2. The windows in the upper two floors have blinds, while those in the basement do not. The basement windows have been modified and possibly enlarged; none of the sash or trim is original.

The facade is constructed of bricks laid in common bond (five courses of stretchers followed by one course of headers). The wall of the first and second stories of the pavilion is set back from the basement wall approximately 2½".

The hyphen spans the approximately 16' 0" between the pavilion and the rear addition. It is three bays wide with two stories and a basement. The facade is topped by a 1' 1" entablature surmounted by a gabled, standing-seam, sheet-metal roof. The entablature used on the hyphen and on the addition is composed of a cornice, which has a cymatium with a fillet and cyma recta; a projecting corona with a fillet and scotia; and a bed molding consisting of a fillet, an ovolo, a fillet, and a cavetto. The architrave is a single fascia with a flush bead at the bottom edge. The hyphen cornice is an original circa 1850 feature, which was moved up from its earlier position six-and-one-half brick courses lower on the wall in circa 1903/1929 when the roof was rebuilt at a higher level. The original wood nailers for the cornice are still in place in the twenty-fifth brick course above the porch deck.

PAVILION V

Although the roof was positioned at a lower level on the hyphen, there was still a second floor level in the connector.

At the first-floor level of the hyphen there is an original (circa 1850) 6/6 window in the center bay trimmed with a 6½"-wide two-fascia architrave (Type T-4) and an original (circa 1850) door in the west bay trimmed with a similar architrave, but 7½" wide (Type T-5). Blinds flank the window. At the second-floor level of the hyphen, a pair of centrally located circa 1903/1929 glazed doors framed with a 6"-wide single-fascia architrave (Type T-6) swings out onto a roof terrace. A small, circa 1903 or later nine-light casement window, located in the east bay of the second floor, is framed with a 3½" single fascia architrave with a perimeter cyma reversa molding.

The bricks used in the hyphen are 7¾" to 8" by 2½" by 3¾", with six courses equal to 1' 5⅛". The basement wall is laid in a common bond (five courses of stretchers followed by one course of headers), and the first and second floor walls are laid in Flemish bond.

A circa 1903/1929 covered porch at the first-floor level extends across the full width of the hyphen. The porch is divided into three bays by fluted columns (approximately 10" in diameter) supporting wood arches that have been trimmed with two-fascia architraves and an incised quatrefoil in each spandrel; the arch reveals are faced with tongue-and-groove boards. A flight of 5' 6"-wide wood stairs descends from the center bay of the porch to a stone platform at ground level. The eight risers are approximately 7¾" high with 11" treads.

Delicate railings, like those used on the east porch, extend between the columns in the east and west bays and continue down along the stairs and at the edge of the retaining wall, creating the basement passage or areaway. Similar railings running between wood pedestals along the edge of the porch roof allow that space to be used as a roof terrace.

The floor of the porch is made up of 3¼"-wide floorboards running north-south; the ceiling is covered with 2½"-wide tongue-and-groove boards, running east-west. Twentieth-century electrical features include a Colonial Revival lamp centered on the porch ceiling, a doorbell on the west architrave of the door, and rigid conduit running up through the floor in the southeast corner.

At the basement level the porch is supported by three brick arches. The center and west arches terminate at ground level; the east arch spans the passage or areaway running north-south between the hyphen and the pavilion. The floor of the passage is approximately 3' 6" to 4' 0" below ground level, and the passage is 4' 9" wide. A similar arched opening is in the east bay of the hyphen basement wall.

ARCHITECTURAL DESCRIPTION

The north facade of the circa 1850 addition is three bays wide with two stories and a basement. A standing-seam, sheet-metal, hipped roof rises above a 1' 1" entablature (similar to the trim used on the hyphen). There are windows in the east and west bays of the first and second floor levels and windows in all three bays of the basement. The first and second floor window openings are original and have their original 6/6 sash and 7"-wide two-fascia architraves (Type T-4). The basement windows were modified in the early twentieth century. The 6/6 sash and 6³/₈"-wide, two-fascia trim (Type T-7) of the two west windows date to their modification. The small horizontal basement window to the east retains its original circa 1850 size, but the trim is a later replacement.

WEST FACADE

From the landscaped gardens to the west of Pavilion V, the west facade of the original pavilion rises up behind the circa 1850 addition. All five bays of the west facade of the 1819-23 pavilion were originally exposed and consisted of a central entrance at the first floor level (similar to the east entrance) and windows in the four flanking bays. There were five windows in the second story. With the addition of the hyphen circa 1850, the center bays were enclosed. Circa 1903/1929 the hyphen was enlarged, leaving only the two north bays and the second story south bay exposed. The four windows in the north bays have typical 6/6 sash, 6¹/₂"-wide two-fascia architraves (Type T-2), and flanking blinds. The second story opening in the south bay matched these windows but was converted to a doorway circa 1929 to provide access to a newly created roof terrace. The glazed double doors are framed by the typical two-fascia architrave (Type T-2).

At the basement level there is a door in the center bay (possibly added with the circa 1850 construction of the hyphen and addition) and four windows. The door is framed with a two-fascia architrave (Type T-8). The windows were modified (probably enlarged) in the early twentieth century, and their 6/6 sash and two-fascia architraves (Type T-3) date to that modification.

The west face of the pavilion, like the east elevation, is constructed of hand-made bricks laid in Flemish bond on the first and second floors; the basement wall is laid in common bond (five courses of stretchers followed by one course of headers). The bricks are 7⁵/₈" by 3⁵/₈" to 3⁷/₈" by 2³/₈", with six courses equal to 1' 5³/₈" to 1' 5³/₄". The basement brickwork was modified when the windows were enlarged in the early twentieth century.

PAVILION V



West facade of Pavilion V

The only section of the hyphen visible from the west is the circa 1903/1929 extension of the first floor of the hyphen to the south face of the pavilion. A two-paneled screen door and a glazed door with a six-light fanlight, located in the west face of the extension, open to a flight of exterior stairs descending west to the basement level. The wooden stairs have eleven 8"-high risers with 10" treads. Beneath the stairs a gate opens into the areaway beneath the hyphen.

The west facade of the rear building is made up of 7 $\frac{3}{4}$ " to 8" by 2 $\frac{1}{2}$ " by 3 $\frac{3}{4}$ " bricks laid in Flemish bond at the first and second floors and laid in common bond at the basement, with six courses equal to 1' 5 $\frac{1}{4}$ ". The elevation has two bays with two stories and a basement. A wood porch added in circa 1929 extends across the addition. There were originally two 6/6 windows in each of the upper floors,

ARCHITECTURAL DESCRIPTION

placed at the north and south ends of the building, with 7½"-wide two-fascia architraves (Type T-4). With the construction of the porch the windows on the first floor were modified, and pairs of glazed doors were placed in the two openings. The doors are framed with 7¼" to 7½"-wide two-fascia architraves (Type T-4). The north door has a pair of two-panel screen doors, and the south door has a five-panel screen door.

Both basement windows were modified in the early twentieth century, and the north window was further modified when a glazed door was inserted in the opening. The 6/6 sash in the south opening and the 5½"-wide single-fascia architraves of both openings (Type T-9 to the north, and Type T-10 to the south) date to those modifications. The north basement opening has a two-panel screened door.

The circa 1929 wood porch at the first-floor level has two engaged wood columns to the east and five wood columns to the west; the columns are 8½" in diameter. The porch floor and ceiling are made up of 2½"-wide tongue-and-groove boards running east-west. Stairs that are 2' 9¼" wide lead down from a landing at the northeast corner of the porch west to the brick pavement beneath the porch. There are eleven risers measuring 7" high with 11"-deep treads (including a 1½" nosing). This stairway was constructed some time after the porch was built; the porch railing originally extended completely across the north end of the porch. The north, west, and south edges of the porch are protected by a 2' 8"-high railing consisting of long, horizontal recessed panels running between the columns capped with a 2¾"-high by 7½"-wide top rail. The recessed panels are made up of 2½"-wide vertical tongue-and-groove boards.

Electrical elements within the porch include a twentieth-century Colonial Revival lighting fixture on the ceiling, and a cast-iron wall bracket lighting fixture with a glass shade. Below the fixture is an early twentieth-century box with tumbler switch. Rigid conduit runs from the fixture into the ceiling and from the box down through the floor.

The space beneath the porch is finished with brick pavers laid east/west with a rowlock course around the perimeter. Brick piers placed beneath each of the porch columns support the structure. Rigid electrical conduit runs from the tumbler switch in the porch to a tumbler switch on the south wall of the addition and branches off to run to a porcelain light socket mounted to the framing beneath the porch.

PAVILION V



South facade of Pavilion V

SOUTH FACADE

The south facade of the original pavilion is three bays wide. There are three windows in the basement. The center and west openings are original but were modified, possibly enlarged, in the early twentieth century. They have 6/6 sash and 5"-wide single-fascia architraves (Type T-3). The east opening does not appear in the Jefferson plan and may have been added or simply modified in the early twentieth century. The east window has a 3/6 sash and a 6½"-wide two-fascia architrave (Type T-11); its perimeter molding appears to be a recent replacement.

The original windows in the first and second stories are approximately centered between the west and center basement windows. These windows are typical of the other windows in the pavilion, with 6/6 sash, Type T-2 two-fascia architraves and blinds.

ARCHITECTURAL DESCRIPTION

The hyphen is three bays wide and spans the area between the rear addition and the pavilion. The first story of the hyphen was extended to align with the south facade of the pavilion in circa 1903/1929. At that time three impressive arched windows, each with 25/25 sash below a nine-light fanlight, were installed to provide light to the new room. The windows are set between fluted wooden pilasters supporting three-fascia architraves trimmed with wood keystones and resting on a continuous wood sill. The roof of the hyphen extension is used as a roof terrace. The roof is covered with flat-seamed, sheet-metal roofing material (2' 2½" by 6' 0" pans) painted red; the edge of the porch is enclosed by wood pedestals and 2' 7"-high railings similar to the railings used on the north roof terrace.

The facade above the porch is topped by a 1' 1" entablature, which duplicates the one on the north facade. This is the original entablature from the south wall of the circa 1850 hyphen (now enclosed in Rooms 207 and 208) relocated here when the hyphen was extended and the roof height increased circa 1903/1929. There are two circa 1903/1929 windows in the second story of the hyphen. They have 6/6 sash, 6¾"-wide two-fascia architraves (Type T-12), and blinds.

The basement of the hyphen's extension has three arched openings. The facade is trimmed with slightly recessed horizontal panels above each arch. The center and east openings are filled in with lattice work. Shallow, brick-paved steps lead through the west opening into a passage enclosed by the arched masonry wall to the south, the brick wall of Room B06 to the north, a gate to the west, and the pavilion to the east. The ceiling of the passage is finished with plaster on circular-sawn lath. The small room (B06) was added circa 1903/1929 with the extension of the hyphen. Wooden steps to the west of that room lead to the first floor of the hyphen. A window at the east end of Room B06 retains its original 6/6 sash and 5¾"-wide single-fascia architrave (Type T-10). An electrical lamp socket with twisted, cloth-wrapped wire is suspended from an old junction box at the east end of the passage ceiling.

Five broad brick steps descend from the south passage entrance to the east end of the passage, where it turns north and continues beneath the hyphen. Within this passage the east face of the hyphen basement has a vestibule in the center, Room B06 to the south, and exterior storage space beneath the porch to the north. The door to Room B06 dates to circa 1903/1929 and is framed by a plain 2"-wide frame. The floor of the vestibule steps up 1' 0" from the floor of the passage and is paved with bricks. The ceiling is formed by the exposed framing of the first floor of the circa 1850 hyphen. The wooden members are covered in multiple layers of

PAVILION V

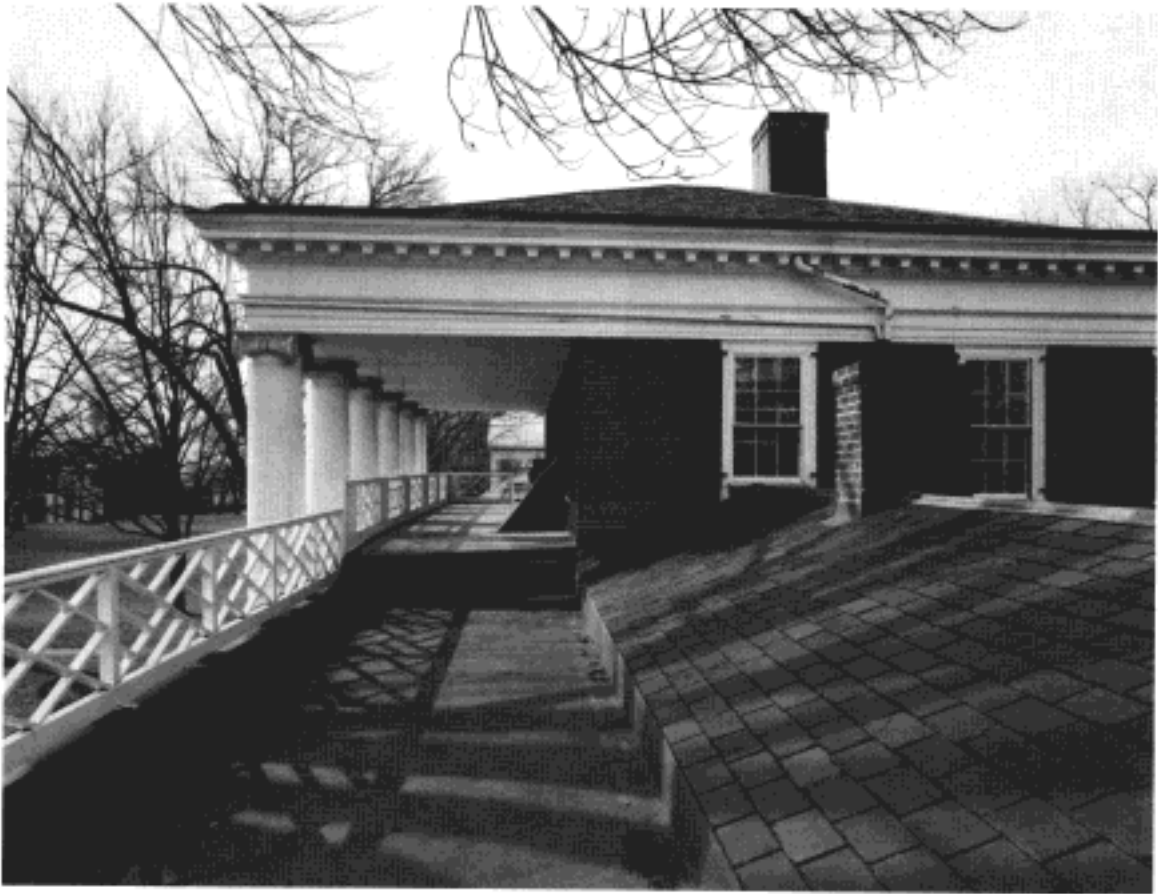

Colonnade and east porch from the north

whitewash. Remnants of old electrical systems, including junction boxes, electrical panels, and wiring, remain on the north wall of the vestibule. A door in the center of the west wall of the vestibule provides access to the basement of the rear addition. The twentieth century, solid-core door has been placed in a circa 1850 opening framed by simple wood framing members.

To the west of the hyphen is the south facade of the rear addition. The first and second stories each have two windows placed closely together near the center of the facade, with original 6/6 sash, two-fascia architraves (Type T-4), and blinds. A small horizontal window, immediately east of and slightly lower than the second story windows, lights the stairway of the rear addition. The window has a 25 light, pivoting, decorative sash and was inserted when the hyphen was enlarged. The two window openings in the basement retain their original six-light casement sash and 6¼"-wide two-fascia architraves.

ARCHITECTURAL DESCRIPTION

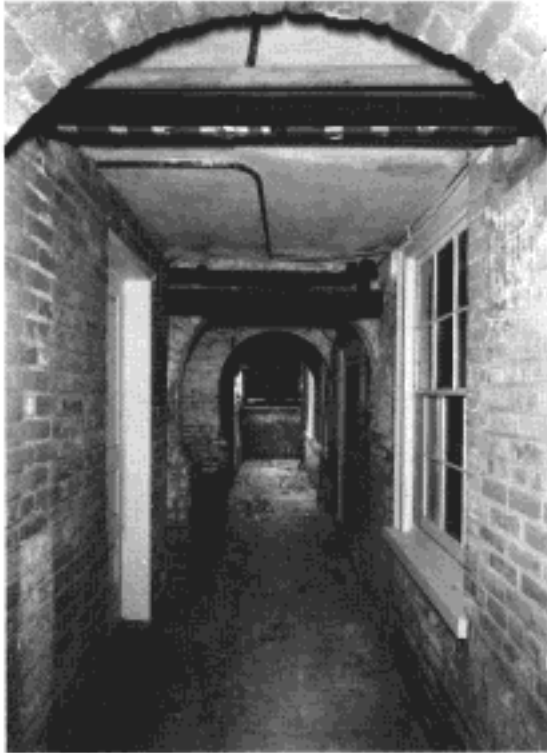

Basement passage between original pavilion and hyphen, looking north



Basement passage beneath Room 106A

Immediately south of the addition a set of wooden stairs descends to the west from the first floor of the hyphen, and a wall, flush with the south face of the hyphen, extends west and then south to enclose the pavilion garden.

PAINT INVESTIGATION

The investigation of the exterior painted elements of Pavilion V revealed approximately 16 layers of accumulated paint on some portions of the original 1819-23 building. The east porch railing is original and was apparently painted more frequently, retaining 23 or more layers of finish. About 13 layers of paint are extant on the wooden surfaces of the circa 1850 rear addition.

Wood elements, including the cornices, window trim and sash, door trim, and the east porch, were originally primed and painted in a yellowish white (2.5Y9/1). Accumulated dirt is very evident between each succeeding application of paint. It

PAVILION V



Entablature and column capital at southeast corner of pavilion



Original wrought-iron holdback for blind

is particularly evident in the nineteenth-century layers. When the rear addition was constructed circa 1850 the same yellowish white color was applied to the trim there and on the older part of the pavilion. In more recent twentieth-century repaintings of the entire pavilion, the color has tended to be much whiter than the earlier finishes.

The paired front entrance doors at the first and second floors were originally grained to simulate mahogany. Later finishes include layers of various dark greens.

The original window blinds retain approximately 13 layers of finishes. A light gray primer is covered in a greenish black (10GY2.5/1) followed by a later, lighter, forest green.

The exterior door in the north facade of the circa 1850 hyphen was first finished in graining that simulated mahogany. This suggests that the mahogany graining on the original east front doors survived into the 1850s.

ARCHITECTURAL DESCRIPTION



*Entablature at southeast corner
of rear addition*



*Ghost of original hyphen entablature appears
on south face of pavilion*

Paint layering on the hyphen entablatures (about 13 layers) indicates that these elements date to circa 1850. The entablatures were moved upward when the hyphen was modified and enlarged circa 1903/1929.

The deck of the east porch is covered in sheet metal that was painted first with a red/brown primer followed by a gray (5Y6/1) finish.

The first-floor window balustrades on the east facade are recent restorations and are covered in about four layers of a white paint.

The front (east) facade retains evidence of an early red linseed-oil-based stain applied to the bricks; the mortar joints were painted white.

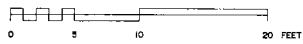
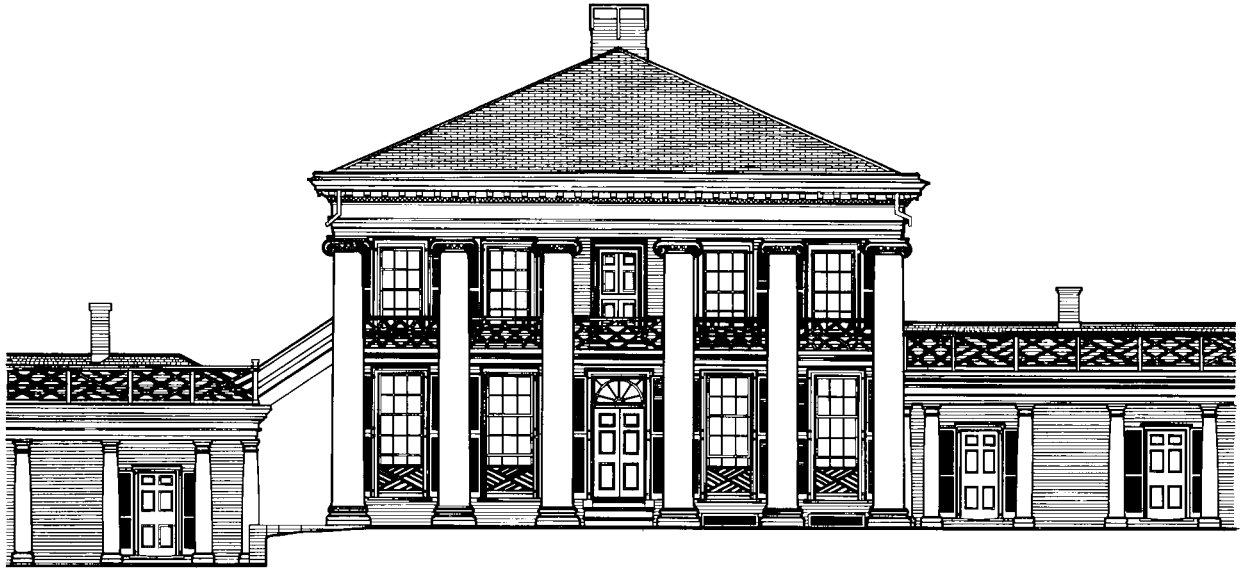

*Top, east elevation
Bottom, north elevation*

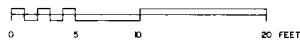
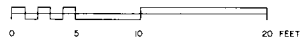
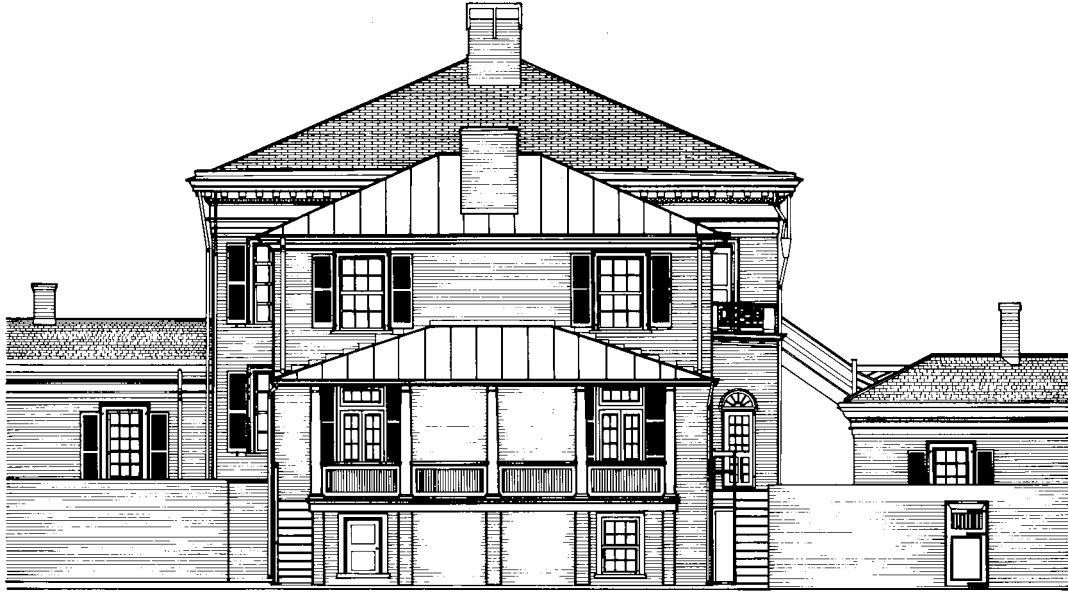

Top, west elevation
Bottom, south elevation

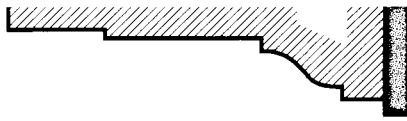

T-1



T-6

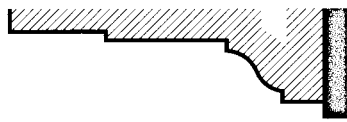

T-2

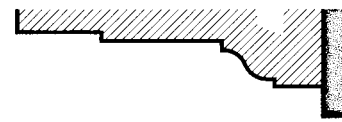

T-7

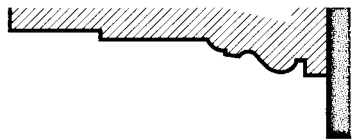

T-3

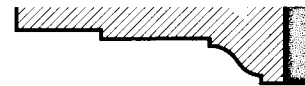

T-8



T-4



T-9

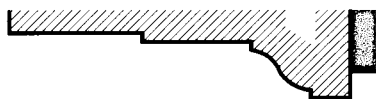

T-5



T-10



ARCHITECTURAL DESCRIPTION

INTERIOR

Pavilion V was examined and analyzed to document its existing condition, to determine where repairs are needed, and to provide a better understanding of the changes and modifications that the building has undergone since its initial construction. A particularly complex series of changes was revealed in the circa 1850 rear addition. These modifications and additions were likely initiated in 1903 and again in 1929 and later. No documentary evidence was discovered that would definitively date this work.

The techniques used in the examination included visual investigation and description, measuring and drawing, and comprehensive photographic documentation of the building.

As part of the physical investigation of Pavilion V, a paint analysis was undertaken to determine the original paint schemes of the interiors and to use as a tool to help in the dating of certain modifications and insertions. The paint colors were matched to those in the *Munsell Book of Color*, Matte Finish Collection, and the information from this analysis is included with the description of each room.

The hardware found on the various doors was also carefully studied to determine the nature of the original fittings and to ascertain whether any original hardware survived *in situ*. At the time of the investigation the pavilion was unoccupied. Considerable demolition and removals had occurred in the building, so it was not possible to record such fittings as light fixtures. Some surfaces were so disturbed or covered by debris that analysis was difficult or impossible.

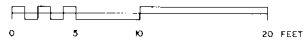
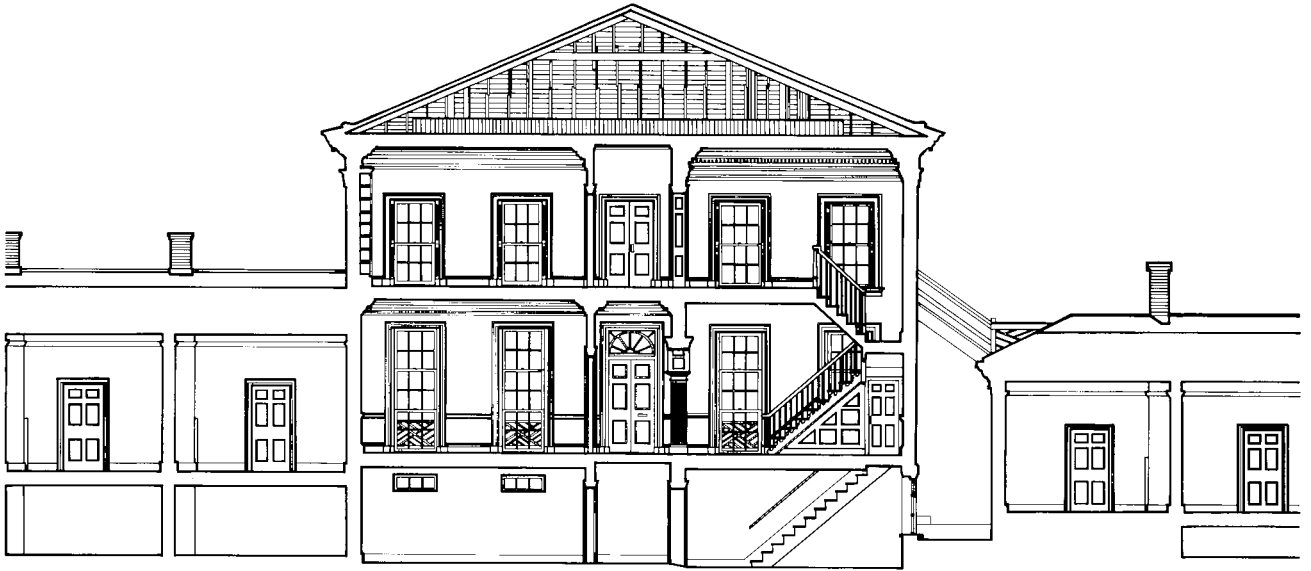

Transverse section, looking east

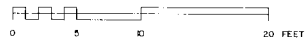

Longitudinal section, looking south



Transverse section, looking west



Longitudinal section, looking north

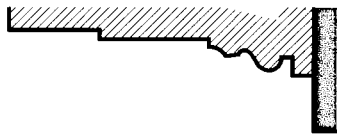

T-11

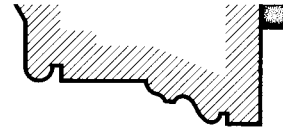

T-16

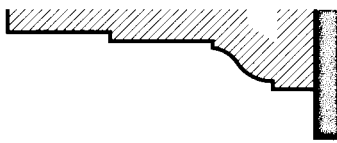

T-12

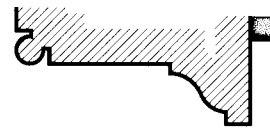

T-17

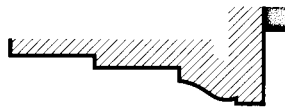

T-13



T-18



T-14

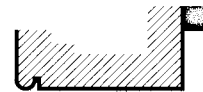

T-19

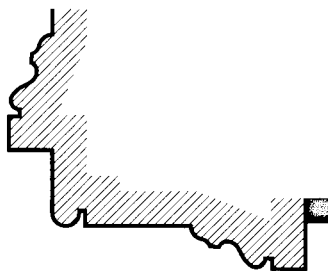

T-15

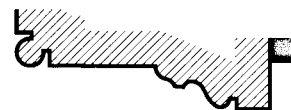

T-20

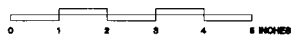

ARCHITECTURAL DESCRIPTION

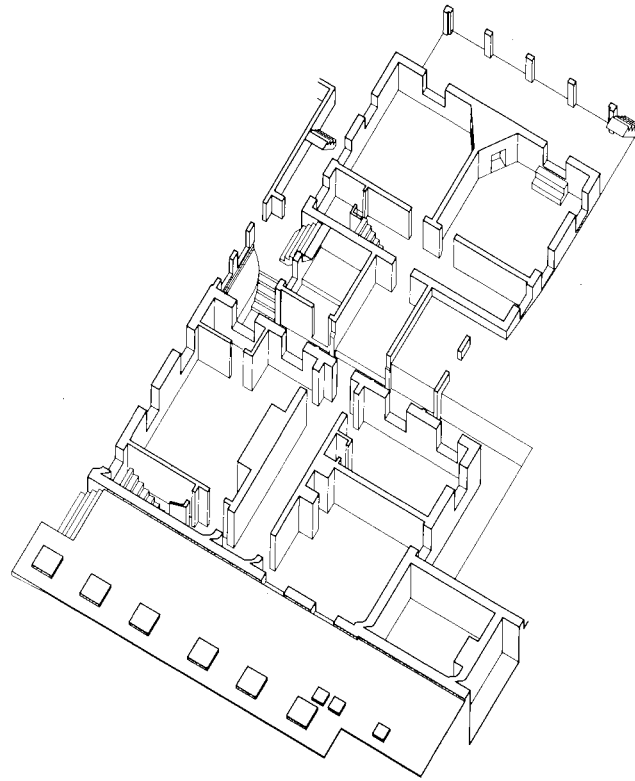

BASEMENT

The present arrangement of the basement of the original 1819-23 pavilion is nearly identical to the Jefferson floor plan. The variations between the current plan and the Jefferson drawing can be accounted for by changes made during the initial construction and by more recent modifications made in the twentieth century. The most dramatic changes involved the replacement of the original brick floors with poured concrete and the modification and enlargement of the windows. This work probably occurred circa 1903/1929.

The original kitchen function of the largest room (B05) is still evident because the much-modified cooking fireplace remains *in situ*. The original functions of the other rooms remain unknown. The basement area was considerably expanded when the rear addition was constructed circa 1850.

The three basement rooms in the addition are not immediately adjacent to the original spaces but instead are joined by an open passage located beneath the two-story connecting passage or hyphen, which joins the first and second floors.

PAVILION V

This arrangement makes the two basements into completely separate areas.

The connecting passage and two of the spaces in the rear addition retain their original brick floor surfaces. Like those in the original pavilion, the windows in the addition have been enlarged and modified, probably at the same time that the other windows were changed.

An additional enclosed basement room (B06) was created when the connector was enlarged circa 1903/1929.

Currently, an extensive area of covered, exterior space exists under the enlarged hyphen.

After the conversion of the pavilion into two separate residences circa 1903, the basements probably became separate areas, each with a kitchen. Both of the kitchens were moved to the first floor prior to the mid-twentieth century.

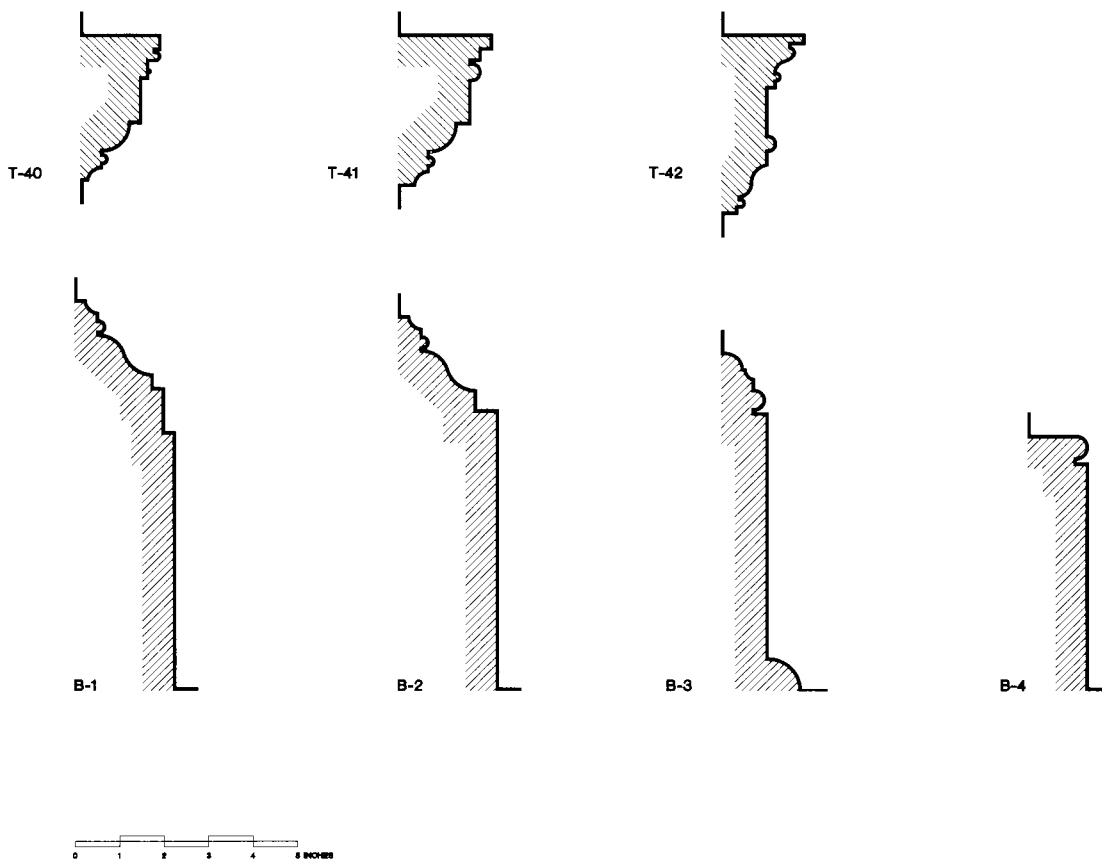

Baseboard and chair rail profiles

ARCHITECTURAL DESCRIPTION

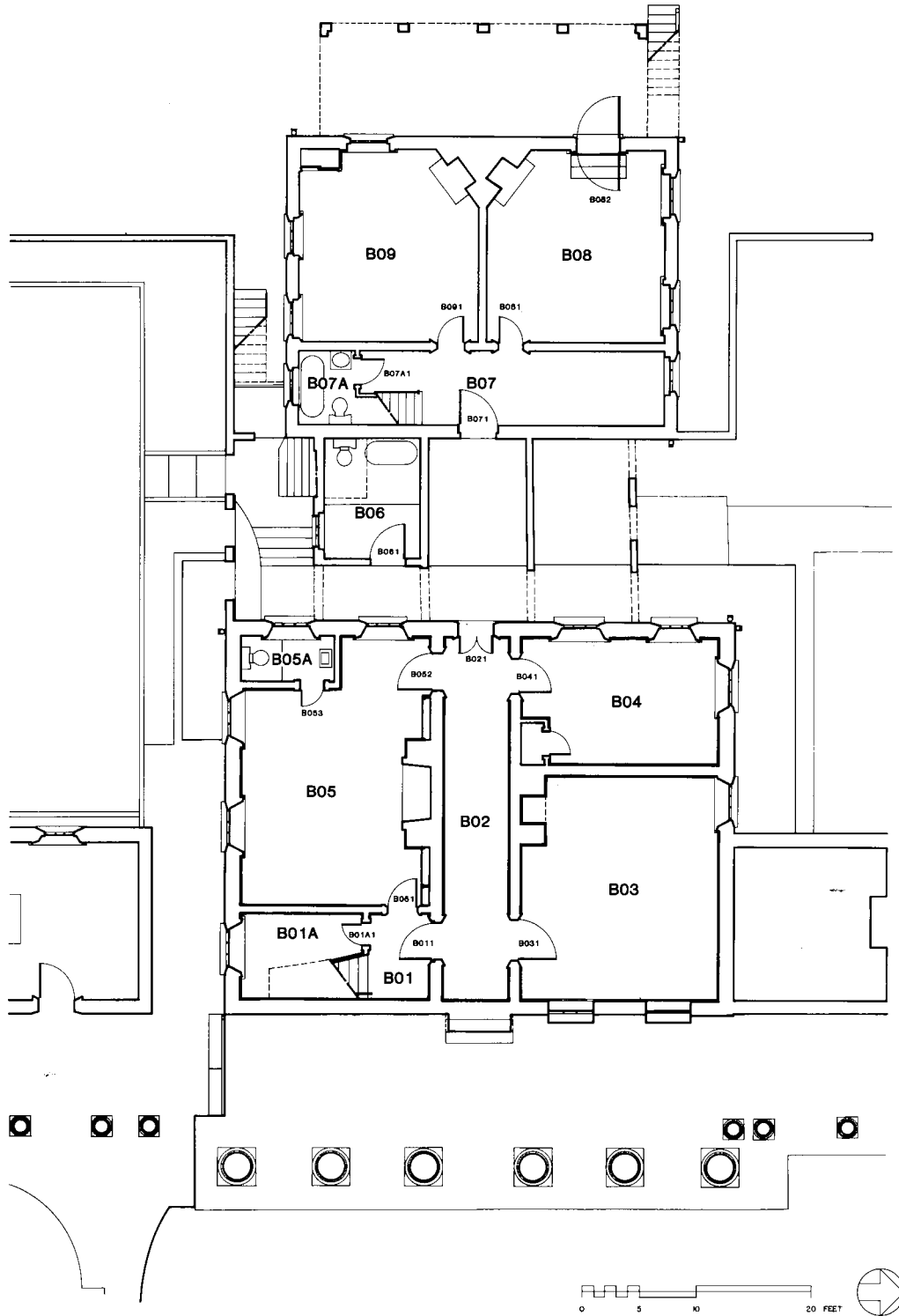

Basement floor plan

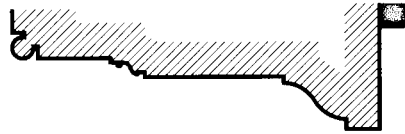

T-21



T-26

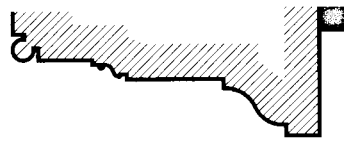

T-22

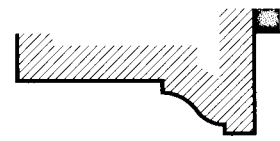

T-27

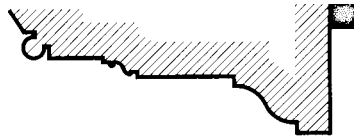

T-23

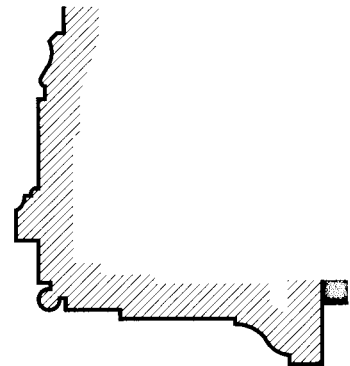

T-28

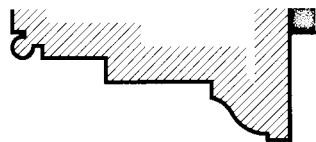

T-24

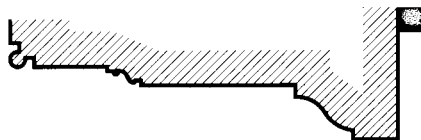

T-25

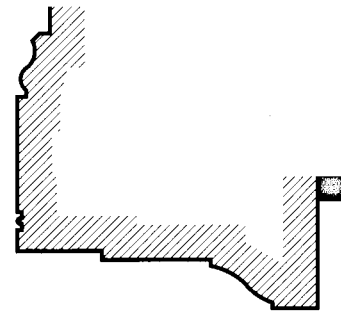

T-29



ARCHITECTURAL DESCRIPTION



Room B01 Front stair hall



Room B02 Hall

ROOM B01 FRONT STAIR HALL.

Some changes have been made to this small stair hall, but in plan the various elements generally follow the Jefferson scheme. On Jefferson's drawing the stair is shown as a straight run, parallel to the east foundation wall. As it exists today, the stair splays or widens as it progresses downward from the first floor. This peculiar arrangement probably became necessary when the stairway was rebuilt in the twentieth century and heating pipes were incorporated into the lower risers.

On the Jefferson plan the doorway into the kitchen (B05) is centered in the west wall. The current door is positioned further to the north; no evidence was found to indicate that Jefferson's drawing was adhered to during construction.

The hall was decreased in size in this century when a partition and doorway were inserted at the foot of the stair between the stairway and the west wall.

Floor: Twentieth-century concrete. Remnants of recent 9" square vinyl tiles (removed in 1992) remain on the floor. Originally, the floor surface may have been brick, as in Pavilion I. It would have been slightly lower than the current floor.

Ceiling: Painted plaster. At the basement level of the stair hall the ceiling is 7' 8" above the floor. Above the stair in the southeast corner the ceiling rises with the first-floor stair carriage. The original ceiling surface consisted of plaster on split-wood lath.

Walls: Plaster on original brick masonry, with the exception of the partition on the west side of the stairway enclosing Closet B01A, which is constructed of 5'-wide vertical tongue-and-groove boards. A 1' 0½"-high fascia board, with a bullnosed molding at the top edge and a large bead at the bottom edge, runs around the four walls of the stairwell marking the first floor level. Above this sill the paneling forming the stair wall on the first floor level is visible.

PAVILION V

Baseboard: A recent, painted black band at the basement level of the stair hall imitates a 6"-high splashboard.

Doors: One original door opening in the north wall with a 5"-wide single-fascia architrave surround (Type T-17), one modified door opening in west wall with a 3¾"-wide single-fascia architrave surround (Type T-15), and one recent door opening in south wall with a plain, 3"-wide casing. The height of the doorway into the kitchen (Room B05) was increased in the late nineteenth or early twentieth century, perhaps in 1903.

No. B011: Original board-and-batten door constructed of 1½" thick tongue-and-groove boards fastened to three horizontal and one diagonal 1½" thick battens (Type D-1). Hardware: Pair of 4" butt hinges and a 3" by 4¼" iron box lock with brass knobs and an oval brass keyhole escutcheon. All of this hardware dates to the twentieth century. The original box lock was 5½" by 6½", and the west door jamb retains a cutout where the lock fitted against that surface.

Windows: The lower half of the original first-floor southeast window extends into the stair hall, and rests on the wood sill marking the first floor level. The window in the south wall of Room B01A would have served this hall prior to the construction of the south partition.

Staircase: The stair has a straight run of eleven treads to a landing at the south end of the hall and then turns west to the first floor level. The beaded-board partition wall enclosing the stair angles to the west so that the width of the stair ranges from 4'0" at the first tread to 2'6" at the landing. A recent pine handrail is surface-mounted to the east wall. The stairway was reconstructed in the twentieth century in its current splayed form.

Heating: A large steel hot water pipe, part of the Lawn's heating system, runs from B01A through the stairs and through the north wall into Hall B02. A pair of copper heating/cooling lines and a copper HVAC pneumatic control line run from B01A and through the north wall above door B011.

Lighting: A lighting fixture is recessed in the ceiling. EMT (electrical metal tubing) and PVC (polyvinyl chloride) electrical conduit run alongside the large heating pipe that extends north-south through the room. A pair of EMT lines run from the south wall of B01A through the north wall of B01. Switch and plastic switchplate on south wall at first floor level. Junction box for light fixture (removed in 1992) on south wall.

Plumbing: Galvanized-steel domestic water line from Closet B01A through north wall.

Other Features: Telephone cable along west and north walls near ceiling between Rooms B01A and B02.

Paint Investigation: The pink sandy plaster wall surface was finished in a thin coat of white plaster. A whitewash was applied first, followed by a yellowish pink (5YR7/6) and a pale pink/beige (10YR8/4).

The trim of the opening in the north wall was first finished in a beige (10YR8/4-7/4) paint covered by a dark brown glaze, producing a wood-grained surface. This original finish was overpainted in six different paints, including a red in the fourth position. The door was grained to match the trim.

ROOM B01A CLOSET

Until the north partition was constructed, this space was part of the Stair Hall. The recent (1992) installation of insulated heating pipes next to the ceiling has destroyed that original plaster on split lath surface.

Floor: Twentieth-century concrete. Originally, the floor may have been brick; if brick, it would have been slightly lower than its existing level.

Ceiling: Painted plaster, 7'7½" above floor. Portions of the original plaster on split-wood lath ceiling survive.

Walls: The south, east, and west walls are plaster on original brick masonry. The recent north partition is ¾"-wide vertical tongue-and-groove boards. The west side of the stair carriage is enclosed with 5"-wide vertical, beaded tongue-and-groove boards, and the bottom surface of the stair carriage is covered with plaster.

Doors: Single door opening in north wall with 3"-wide plain casing. This opening is a recent creation.

No. B01A1: A recent 1¼" thick stile-and-rail door with two large, recessed panels (Type D-6). Hardware: Pair of 3½" butt hinges and a 3" by 4¼" cast-iron box lock with pair of brass knobs and a keyhole escutcheon.

Windows: One window opening in the south wall with plain splayed reveals and a 5"-wide single-fascia architrave (Type T-16) terminating on a ½"-thick sill and a 5"-high apron. The 3/6 wood sash have 12" by 12" panes, ¼"-wide angular muntins, and a sweep thumb latch on the meeting rails. The upper sash is fixed in place. The window is made secure by a series of horizontal iron bars fixed in the interior face

ARCHITECTURAL DESCRIPTION



Room B01 Front stair hall



Room B02 Hall

ROOM B01 FRONT STAIR HALL.

Some changes have been made to this small stair hall, but in plan the various elements generally follow the Jefferson scheme. On Jefferson's drawing the stair is shown as a straight run, parallel to the east foundation wall. As it exists today, the stair splays or widens as it progresses downward from the first floor. This peculiar arrangement probably became necessary when the stairway was rebuilt in the twentieth century and heating pipes were incorporated into the lower risers.

On the Jefferson plan the doorway into the kitchen (B05) is centered in the west wall. The current door is positioned further to the north; no evidence was found to indicate that Jefferson's drawing was adhered to during construction.

The hall was decreased in size in this century when a partition and doorway were inserted at the foot of the stair between the stairway and the west wall.

Floor: Twentieth-century concrete. Remnants of recent 9" square vinyl tiles (removed in 1992) remain on the floor. Originally, the floor surface may have been brick, as in Pavilion I. It would have been slightly lower than the current floor.

Ceiling: Painted plaster. At the basement level of the stair hall the ceiling is 7' 8" above the floor. Above the stair in the southeast corner the ceiling rises with the first-floor stair carriage. The original ceiling surface consisted of plaster on split-wood lath.

Walls: Plaster on original brick masonry, with the exception of the partition on the west side of the stairway enclosing Closet B01A, which is constructed of 5'-wide vertical tongue-and-groove boards. A 1' 0½"-high fascia board, with a bullnosed molding at the top edge and a large bead at the bottom edge, runs around the four walls of the stairwell marking the first floor level. Above this sill the paneling forming the stair wall on the first floor level is visible.

PAVILION V

Baseboard: A recent, painted black band at the basement level of the stair hall imitates a 6"-high splashboard.

Doors: One original door opening in the north wall with a 5"-wide single-fascia architrave surround (Type T-17), one modified door opening in west wall with a 3¾"-wide single-fascia architrave surround (Type T-15), and one recent door opening in south wall with a plain, 3"-wide casing. The height of the doorway into the kitchen (Room B05) was increased in the late nineteenth or early twentieth century, perhaps in 1903.

No. B011: Original board-and-batten door constructed of 1⅛" thick tongue-and-groove boards fastened to three horizontal and one diagonal 1⅛" thick battens (Type D-1). Hardware: Pair of 4" butt hinges and a 3" by 4¼" iron box lock with brass knobs and an oval brass keyhole escutcheon. All of this hardware dates to the twentieth century. The original box lock was 5½" by 6½", and the west door jamb retains a cutout where the lock fitted against that surface.

Windows: The lower half of the original first-floor southeast window extends into the stair hall, and rests on the wood sill marking the first floor level. The window in the south wall of Room B01A would have served this hall prior to the construction of the south partition.

Staircase: The stair has a straight run of eleven treads to a landing at the south end of the hall and then turns west to the first floor level. The beaded-board partition wall enclosing the stair angles to the west so that the width of the stair ranges from 4'0" at the first tread to 2'6" at the landing. A recent pine handrail is surface-mounted to the east wall. The stairway was reconstructed in the twentieth century in its current splayed form.

Heating: A large steel hot water pipe, part of the Lawn's heating system, runs from B01A through the stairs and through the north wall into Hall B02. A pair of copper heating/cooling lines and a copper HVAC pneumatic control line run from B01A and through the north wall above door B011.

Lighting: A lighting fixture is recessed in the ceiling. EMT (electrical metal tubing) and PVC (polyvinyl chloride) electrical conduit run alongside the large heating pipe that extends north-south through the room. A pair of EMT lines run from the south wall of B01A through the north wall of B01. Switch and plastic switchplate on south wall at first floor level. Junction box for light fixture (removed in 1992) on south wall.

Plumbing: Galvanized-steel domestic water line from Closet B01A through north wall.

Other Features: Telephone cable along west and north walls near ceiling between Rooms B01A and B02.

Paint Investigation: The pink sandy plaster wall surface was finished in a thin coat of white plaster. A whitewash was applied first, followed by a yellowish pink (5YR7/6) and a pale pink/beige (10YR8/4).

The trim of the opening in the north wall was first finished in a beige (10YR8/4-7/4) paint covered by a dark brown glaze, producing a wood-grained surface. This original finish was overpainted in six different paints, including a red in the fourth position. The door was grained to match the trim.

ROOM B01A CLOSET

Until the north partition was constructed, this space was part of the Stair Hall. The recent (1992) installation of insulated heating pipes next to the ceiling has destroyed that original plaster on split lath surface.

Floor: Twentieth-century concrete. Originally, the floor may have been brick; if brick, it would have been slightly lower than its existing level.

Ceiling: Painted plaster, 7'7½" above floor. Portions of the original plaster on split-wood lath ceiling survive.

Walls: The south, east, and west walls are plaster on original brick masonry. The recent north partition is ¾"-wide vertical tongue-and-groove boards. The west side of the stair carriage is enclosed with 5"-wide vertical, beaded tongue-and-groove boards, and the bottom surface of the stair carriage is covered with plaster.

Doors: Single door opening in north wall with 3"-wide plain casing. This opening is a recent creation.

No. B01A1: A recent 1¼" thick stile-and-rail door with two large, recessed panels (Type D-6). Hardware: Pair of 3½" butt hinges and a 3" by 4¼" cast-iron box lock with pair of brass knobs and a keyhole escutcheon.

Windows: One window opening in the south wall with plain splayed reveals and a 5"-wide single-fascia architrave (Type T-16) terminating on a 1½"-thick sill and a 5"-high apron. The 3/6 wood sash have 12" by 12" panes, ¾"-wide angular muntins, and a sweep thumb latch on the meeting rails. The upper sash is fixed in place. The window is made secure by a series of horizontal iron bars fixed in the interior face

ARCHITECTURAL DESCRIPTION

of the opening. This window is not included in the Jefferson floor plan and may not be original. The opening may have been created or enlarged circa 1903/1929 when the other basement windows may also have been enlarged.

Heating: A large steel hot-water pipe with foil-backed insulation, part of the Lawn's heating system, runs along the south and east walls of the room and north through the stair carriage. A pair of copper heating/cooling pipes and an HVAC pneumatic control line run through the north and west wall; the air line branches off to run to a pressure regulator mounted to the south end of the stair wall. A pair of radiator pipes runs through the closet from Room B05 to service a radiator in Room 104.

Lighting: An incandescent porcelain utility fixture is surface-mounted to the ceiling. Two rigid conduits and two flexible armored cables extend from the fixture into the ceiling.

Large sheet metal electrical pull-boxes are located along the south and east walls. EMT and PVC lines run from the pull-boxes north through the stair carriage. A pair of EMT lines runs from the west end of the boxes into the ceiling and then north into Room B01. An EMT line extends into the east wall through a sheet metal panel screwed to the wall. Another EMT conduit near the floor runs from the west end of the boxes into Room B05, where it is capped.

Plumbing: Galvanized-steel domestic water line through south wall, up to ceiling, and out through north wall.

Other Features: Telephone cable along west wall near ceiling.

Built-in bookcases along the west wall are 5' 0" high and 10" deep, with five levels of fixed shelves. The bases of the units are trimmed with a 6"-high splashboard with quarter-round shoe molding, and the tops of the cases have denticulated courses and plain shelves. A 9"-deep shelf extends across west wall, supported by a pair of carved brackets and a small molding.

Paint Investigation: The remnants of the original plaster ceiling retain evidence that suggests that the ceiling surface was initially unpainted. The first applied finish was a pale pink/beige (10YR8/4) paint that matches the third finish used on the walls.

Twenty-two finishes were found on the ceiling.

The window trim was finished first in a cream/beige (10YR8/2-9/2), which became very soiled prior to being repainted. Three additional paint finishes were applied to the soiled surface.

ROOM B02 HALL

This central hall connects all four of the basement rooms in the original pavilion. It is directly below the first and second floor halls and has the same configuration.

The Jefferson basement floor plan includes some details that differ from the plan as it is today. The exterior doorway at the west end of the hall does not appear on Jefferson's plan. The profile of the architrave is of a type not original to the pavilion, indicating that the doorway was a later insertion, probably added when the pavilion was enlarged circa 1850.

Jefferson's plan indicates that the entrance into Room B03 was to be through the arched recess in the north chimney foundations. The narrowness of the arched space, as constructed, and the detailing of the actual entrance to the room indicate that in this case it was not constructed according to the Jefferson plan.

Floor: Twentieth-century concrete. Remnants of 9" square vinyl tiles (removed in 1992) remain on the floor. The original floor was slightly lower and was probably formed of bricks.

Ceiling: Original plaster on lath, painted, 7' 10½" above the floor.

Walls: Original plaster on brick masonry.

Baseboard: Twentieth-century 6½"-high concrete splashboard.

Doors: Four original door openings with 5½"-wide, two-fascia architrave surrounds (Type T-17). A fifth opening, the exterior doorway at the west end of the hall, has a different two-fascia architrave (Type T-13); this opening was created when the rear addition was constructed circa 1850. The Jefferson plan shows the exterior rear doorway in the kitchen (Room B05) and not in this hall.

No. B021: Pair of doors with each leaf composed of 1⅛"-thick vertical beaded boards fastened to three horizontal battens on the east face (Type D-2). Hardware: Each leaf has a later pair of 4" butt hinges. The north leaf also has a later 3" by 4" cast-iron box lock with pair of hollow steel knobs and an escutcheon and a 2½"-high brass slide-bolt at the top edge of the door. The south leaf features the lock keeper and a 6" iron slide bolt at the top of the door. The doors are original to the opening but they were initially supported on 5"-high hinges. There is evidence for earlier box locks.

Heating: Radiator pipes running from the front stair hall (Room B01) into Room B04 extend along the east wall.

PAVILION V

Lighting: Rigid metal conduit runs from electrical boxes to switches on east and west walls, duplex outlet on south wall, 30-amp safety switch on south wall servicing hot water heater, and two ceiling-mounted boxes with porcelain utility light fixtures. The conduit branches off to run up through the floor, north into Rooms B03 and B04, and south into Rooms B01 and B05.

An electrical panel is mounted to the east end of the south wall; it contains ten 20-amp breakers and a main. EMT connects this panel to a pull-box above door B011, and a pair of EMT conduits runs from the box through the north wall into Room B03. A third EMT line runs from the box west to the 1850 addition.

An old metal box embedded in east wall houses three old fabric-wrapped cables, cut off.

Plumbing: A galvanized-steel domestic water line enters the hall through the south wall and branches off to run north into Room B03 and west to a "Mor-Flo Industries of Johnson City, TN" 82-gallon electric hot water heater; galvanized steel pipes run from the hot water heater into Rooms B05, B01, B03, and through the west wall.

Other Features: Telephone cable to box on east wall and north to Room B03; station wire from box is routed to telephone jacks in pavilion. Old telephone wiring extends from box to west wall.

Paint Investigation: The white plaster wall surface was finished first in a whitewash that has yellowed to a beige (2.5Y8/4) color. This layer was then covered by ten or more layers of whitewash.

The original trim of the door to Room B03 was grained. This was covered with a second grained finish, followed by a deep red (7.5R3/4) paint.

The later doorway in the west wall has trim that was first painted in a deep red/brown (7.5R3/4) color. The outer molding is a later addition to the trim and does not feature the red/brown finish.

ROOM B03 STORAGE

The original function of this large room is unknown. It may have served as a storage room, as it did most recently.

Although the Jefferson plan of this room does not include the two small windows in the east wall and indicates that the entrance was to be located in the arched recess of the chimney foundation, it is likely that the present windows and the doorway are original openings.

All of the basement windows have been modified in some manner, probably enlarged, and that is the case with the window in the north wall.

Recent work (1992) involving the installation of piping and conduits has considerably damaged the original plaster and masonry of the north and south walls.

Floor: Twentieth-century concrete. The current surface is slightly higher than the original surface, which was probably of brick.

Ceiling: Original plaster on split-wood lath, 7' 5" above floor. There are some areas where expanded-metal lath and gypsum plaster have been installed.

Walls: Original plaster on brick masonry, with areas of more recent plaster repair.

Baseboard: Twentieth-century 6½"-high concrete splashboard.

Doors: One original door opening in south wall with 5"-wide, two-fascia architrave surround (Type T-17).

No. B031: Original board-and-batten door composed of 1½" thick vertical beaded boards fastened to three horizontal battens (Type D-3). Hardware: Pair of 4" butt hinges and a 3¾" by 4¾" iron box lock with brass knobs. The hardware dates to the twentieth century.

Windows: One original window opening in the north wall with plain splayed reveals and a 5"-wide architrave surround (Type T-16) terminating on a 1½" thick sill with 5"-high apron. The window has 6/6 double rope-hung wood sash with 12" by 14" panes, ⅝" muntins, and a sweep thumb latch on the meeting rails. The west end of the window trim is buried in the west wall. Nine horizontal iron bars formerly provided security. The window opening may have been enlarged in the later nineteenth century or perhaps circa 1903/1929. The trim and sash date to that modification.

Two original window openings in east wall near ceiling, with plain wood frames. Each opening has a three-light awning sash, which swings into the room on a pair of 2¼" cast-iron butt hinges. The panes are 10" by 12", and the plain, rectangular muntins are ⅞" wide. Wood stops mounted to the sill are used to hold the window shut. Although these small openings are not shown on the Jefferson plan, they may in fact be original. The sash are twentieth-century replacements.

Fireplace: The brick foundation of the north chimney mass is located in the southwest corner of the room. The mass includes an arched recess. There is no evidence that this recess served as the

ARCHITECTURAL DESCRIPTION

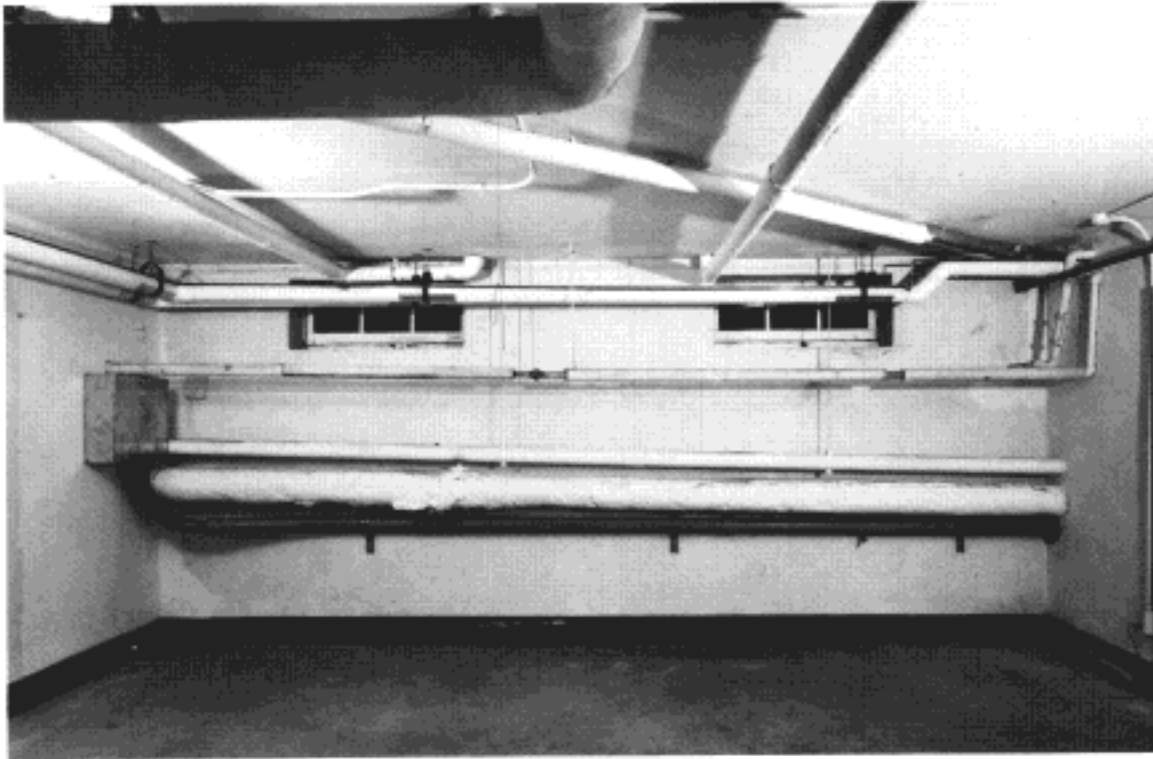

Room B03 Storage

entry into the room from the hall as shown in Jefferson's plan.

Heating: Large steel radiator pipe, hung from the ceiling, enters through the west wall and exits through the north wall, with pipes branching off to service the radiators in Rooms 102 and 203. Another large steel hot water pipe, part of the Lawn's main heating system, runs along the east wall, exiting the pavilion through the north wall. A pair of insulated heating/cooling copper lines and a copper HVAC pneumatic control air line run along the east wall and turn to exit the pavilion through the center of the north wall.

Lighting: Incandescent porcelain utility fixture, covered with duct tape. Rigid metal conduit runs between light fixture and duplex receptacle east of door B031 and branches off to run through north wall. Another conduit runs to a junction box on the ceiling in the northwest corner of the room. A large pull-box is located on the north wall.

Plumbing: A galvanized-steel water line enters the room through the east wall and extends south into

Room B02, where it exits the pavilion through the west wall.

Paint Investigation: The trim of the doorway, which is an original feature of the room, was first covered in a cream-colored primer followed by a medium grey (5Y6/1) finish. This surface was later covered by a grained finish with a very noticeable dirt layer. Two additional paint layers were applied over the soiled surface.

Layers found on the north window trim include an initial finish of pink/beige and a brown glaze, which formed a grained surface corresponding to the second finish on the door trim. This surface was then covered by two additional layers: a cream and a white.

ROOM B04 WORKROOM

The ample natural light provided by the three window openings indicates that this room may have been occupied by a household servant. The three windows have been modified; they probably were

PAVILION V



Room B04 Workroom

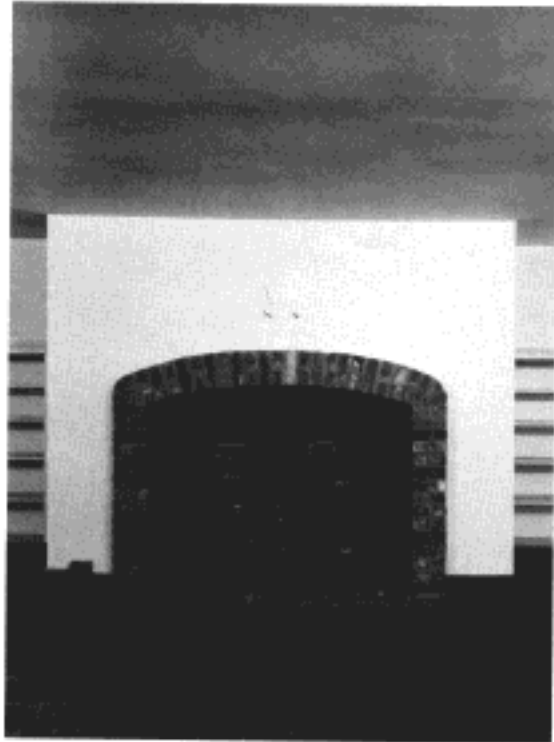

Room B05 Den (original kitchen)

originally like the still extant basement windows of Pavilion II, which are smaller and feature 3/6 sash. A closet was constructed in the southeast corner, perhaps circa 1929 or later.

Floor: Twentieth-century concrete. Remnants of 9" square vinyl tiles (removed in 1992) remain on the floor. This floor is slightly higher than the original surface, which was probably of brick.

Ceiling: Painted plaster, 7' 5½" above the floor. The original surface was plaster on split-wood lath, and much of that finish appears to survive.

Walls: Original plaster on brick masonry.

Baseboard: Twentieth-century 6½"-high concrete splashboard.

Doors: One original door opening in south wall with 5"-wide two-fascia architrave surround (Type T-17).

No. B041: Original board-and-batten door constructed of 1½" vertical tongue-and-groove boards fastened to three horizontal battens (Type D-4). 2' 0" wide by 1' 9" high recent plywood panels have been surface mounted to both faces of the door. Hardware: Pair of 4" butt hinges and a 3¾" by 4¾"

iron box lock with a pair of black ceramic knobs. The lock is marked "WWII."

Windows: Three window openings, two in the west wall and one in the north wall, with plain splayed reveals and 5"-wide single-fascia architraves (Type T-16) terminating on 1½" thick sills and 5"-high aprons. Each window has a 6/6 double rope-hung sash with 12" by 14" panes, ¾" muntins, and sweep thumb latches on the meeting rails. The Jefferson plan does not include a window in the north wall. All of the windows have been modified, probably enlarged, and none of the sash or trim is original. This makes it impossible to determine whether the north window opening is original.

Heating: One-column, eighteen-section radiator hung from the ceiling with large iron bolts. A large steel pipe from Room B03 runs through the east wall and exits the pavilion through the west wall, with pipes branching off to service the ceiling-hung radiator and the radiators in Rooms 102 and 204.

Lighting: A fluorescent fixture is hung from the ceiling near the center of the room. Rigid metal conduit running along the ceiling enters through

ARCHITECTURAL DESCRIPTION

the south wall and extends to the ceiling fixture and over to an electrical box at the northwest corner of the ceiling. The conduit branches off to service duplex receptacles on the east and west walls. "Wire-mold" runs from the ceiling conduit to a switch west of door B041. Bundles of wiring wrapped with tape enter the room through the south wall and run along the west wall to the northwest corner of the room.

Other Features: Closet B04A was removed from the southeast corner of the room in 1992. The closet was built of vertical beaded boards and measured approximately 3' 9" by 2' 5", with 4" partition walls. The detailing of this closet, the toilet room in Room B05, and the doorway partition in Room B01 indicates that all of these features were constructed at the same time, possibly circa 1929 or later.

Obsolete telephone cable runs from the south wall to the northwest corner of the room. The cable is cut at both ends.

ROOM B05 DEN (ORIGINAL KITCHEN)

This large room originally functioned as the kitchen for the professor occupying the pavilion. Food was cooked in the large fireplace, which is still extant in a much modified form, centered on the north wall. The Jefferson floor plan clearly delineates this fireplace. Jefferson's plan shows only a single window centered in the south wall and a single window and exterior doorway in the west wall. The current conditions are much different. Because the windows were modified, probably enlarged, in the late nineteenth or early twentieth century, it has not been possible to determine if the Jefferson plan is a true representation of the 1819-23 conditions. The room may have continued to function as the kitchen until the current kitchen was installed in Room 106 on the first floor. This may have occurred circa 1929 or even later. The installation of the toilet room (B05A) in the southwest corner may have occurred circa 1929.

Floor: Twentieth-century concrete. Remnants of 9" square vinyl tiles (removed in 1992) remain on the floor. The floor surface is slightly higher than the original surface, which was probably brick.

Ceiling: Painted plaster on expanded metal lath, 7' 7½" above floor. The original surface was of plaster on split-wood lath.

Walls: The walls are all original plaster on original brick masonry, with the exception of the walls

enclosing the bathroom (B05A) in the southwest corner of the room, which are plaster on lath.

Baseboard: Twentieth-century 6½"-high plain concrete splashboard.

Doors: Three door openings with wood surrounds. The original north opening has a 5"-wide two-fascia architrave surround (Type T-17). The east opening has a 4¼"-wide single-fascia architrave (Type T-20). This is an original opening that was modified (increased in height) with a new door and trim in the late nineteenth or early twentieth century. The west opening into Room B05A is a twentieth-century doorway with a plain 3½"-wide casing.

No. B051: 1½"-thick stile-and-rail door with six recessed panels (Type D-7). Hardware: Pair of 3½" butt hinges and a 3¾" by 4¾" iron box lock with a pair of black ceramic knobs. The lock is marked "WWII." This door dates to the late nineteenth or early twentieth century.

No. B052: Original board-and-batten door constructed of 1⅛" thick vertical tongue-and-groove boards fastened to three horizontal battens (Type D-5). Hardware: Pair of 4" butt hinges and a 3" by 4¼" iron box lock with brass knobs. The hardware dates to the twentieth century.

No. B053: A 1¼"-thick stile-and-rail door with two large, recessed panels (Type D-6). Hardware: Pair of 3½" butt hinges and a slide bolt. This door may date to circa 1929.

Windows: Three window openings (two in the south wall, one in the west wall) with plain splayed reveals and 5"-wide single-fascia architrave surrounds (Type T-16) terminating on 1" thick sills. Each of the windows has 6/6 double-hung wood sash with 12" by 14" panes. The southeast window sash appear to have been replaced; there are ⅝" muntins in the lower sash, 1¼" muntins in the upper sash, and part of a sweep thumb latch is attached to the lower meeting rail. The southwest window has ⅝" muntins in the lower sash, ¼" muntins in the upper sash, and part of a sweep thumb latch on the upper meeting rail. The west window has ¼" muntins and a sweep thumb latch attached to the meeting rails. These windows were modified, probably enlarged, circa 1903/1929. The original conditions were probably similar to the extant windows in the basement of Pavilion II. In the Jefferson basement plan the north window in the west wall is shown as a doorway. If the hall doorway (B021) is a later insertion, which it does appear to be, then the rear exterior basement door may have been located here.

PAVILION V

Fireplace: The original 9' 3"-wide chimney breast projects 2' 4" from the north wall and has a brick firebox and surround with a segmental arch. The opening is 5' 0" wide, 3' 8" high at the spring line, and 4' 0" high at the crown. The bricks of the firebox are 2½" high by 7¾" to 8" long, while the bricks of the firebox floor are 2½" high by 7" to 8" long by 3½" wide. The surround bricks are 2½" by 8" by 3¾". The firebox was repaired and rebuilt in the twentieth century, and the projecting brick surround is a recent creation. The floor of the firebox is now considerably higher than the original surface, which would have been at the same level as the original brick floor.

Heating: Four-column, 17-section cast-iron, hot-water radiator, marked "Weil-McLain Co." and "Cameo," sits between the two south windows. Insulated steel radiator pipes enter the room through the south wall and run near the ceiling along the south and west walls; the pipes exit the pavilion through the west wall. The pipes branch up through the ceiling to the radiators in Room 103 and through the east wall to the radiator in Room 104.

A pair of insulated copper pipes and a HVAC pneumatic control line enter building through south wall and run east into Room B01A.

Lighting: Two electrical lighting fixtures recessed in the ceiling. Electrical box with switch south of door B051; "Wiremold" conduit running from switch to electrical boxes with duplex receptacles on east and south walls. Duplex receptacle in partition enclosing Room B05A. Electrical boxes with two duplex receptacles on north partition of Room B01A and north wall of Room B05 connected with "Wiremold" conduit. Rigid metal conduit from Room B02 extends along east wall to a electrical box with 220-volt receptacle on south wall (for air conditioning unit).

Plumbing: Pair of domestic water lines run along west wall between Rooms B05A and B02.

Other Features: 5' 3"-high by 10"-deep built-in bookcases flank the chimney breast. The bookcases are trimmed with 9¼"-high beveled baseboards with quarter-round shoe moldings and a 4"-high denticulated cornice. Each bookcase has five levels of fixed bullnosed shelves. These bookcases date to the late nineteenth or early twentieth century and may have been used upstairs or in some other part of the pavilion.

Paint Investigation: The pink sandy plaster and white finish plaster wall surface retains at least eleven layers of painted finishes. The earliest layers

include a pink (2.5YR8/6-7/6) finish followed by a pink/beige (5YR7/4) finish.

The trim of the doorway in the north wall is composed of the original plain surround and an added outer molding. The original surface was finished in two successive applications of a pink/beige and brown glaze that formed a grained surface. This was overpainted with ten later finishes. The molding was not added until the sixth finish, another grained surface, was applied. The windows were modified at the same time; they have the same grained finish.

ROOM B05A TOILET ROOM

The construction of this small toilet room in the southwest corner of the original kitchen occurred in this century, probably circa 1929, when other work was undertaken in the pavilion. The door type used here matches the doors of the built-in closet in Room B04 and the door in the south partition wall of the stair hall (B01).

Floor: Twentieth-century concrete. An 8"-high wood platform has been built into the south end of the room, to allow for plumbing lines below the toilet.

Ceiling: Painted plaster on expanded metal lath 7' 6" above floor.

Walls: The south and west walls are plaster on original brick masonry, and the twentieth-century north and east walls are plaster on lath.

Baseboard: A quarter-round shoe molding runs along the north edge of the wood platform. There is no other baseboard in the room; however, an 8"-high black band has been painted at the base of the walls to imitate a splashboard.

Doors: One opening in the east wall with plain 3½" casing.

Windows: An original window opening in the west wall, with plain splayed reveals and a 5"-wide single-fascia architrave (Type T-16) terminating on a 1" thick sill. The 6/6 double rope-hung sash have 12" by 14" panes, ⅝" muntins, and a sweep thumb latch on the meeting rails. This opening was modified, probably enlarged, in the late nineteenth or early twentieth century.

Heating: A large hot-water heating pipe runs from the south wall of Room B05, along the south and west walls of Room B05A and into the north wall of Room B05. Pipes branch off to run through the west wall and into the rear addition.

Lighting: Incandescent lighting fixture recessed into the ceiling. Switchplate incorporating a switch

ARCHITECTURAL DESCRIPTION

and a electric receptacle north of door B053.

Plumbing: Enameled, cast-iron lavatory mounted to north wall. "Made in United States of America by American Radiator & Standard Sanitary...", and "4 5 87 Baltimore" are cast into the bottom of the basin. Chromed fittings.

Vitreous china toilet marked "11-24-42" and "Douglas Leader," against south wall.

Other Features: Chromed toilet paper holder removed in 1992 from east wall. Chromed soap dish on north wall.

ROOM B06 LAUNDRY (BATHROOM)

This room was created when the circa 1850 connector was enlarged circa 1903/1929. The original function of the space is not known, but it currently serves as a bathroom. There is no access to this small room from the interior of the pavilion. The door in the east wall opens to a protected but open corridor, which extends along the back wall of the original 1819-23 pavilion and is open to the weather at each end.

Floor: Twentieth-century concrete. The concrete floor steps up 9½" above the exterior pavers. Within the room, a 9½"-high by 4' 6"-deep concrete platform is built against the west wall.

Ceiling: Painted plaster on expanded metal lath 7' 5" above floor. In the southwest corner of the room the ceiling slopes down to follow an exterior flight of stairs. The ceiling was originally formed of plaster on sawn wood lath dating to circa 1903/1929.

Walls: Plaster on brick masonry. The masonry forming the north and west walls dates to circa 1850. The other walls were constructed circa 1903/1929.

Doors: One circa 1903/1929 door opening in east wall with 2" casing.

No. B061: A 1¼"-thick stile-and-rail door with two horizontal and two vertical raised panels (Type D-8). Hardware: Pair of 2¾" butt hinges, and 4½" by 3½" cast-iron box lock with oval black pottery knobs. "Reading Hardware Co, Reading PA, USA" is cast into the lock's strike plate. A 2½" by 3¾" "Corbin" deadbolt is mounted above the lock.

Windows: One circa 1903/1929 window in the south wall framed with a 4"-wide architrave (including a recent stop molding) terminating on a plain 3" thick sill. The 6/6 double rope-hung sash have 12" by 14" panes, ⅝" muntins, and a recent sweep thumb latch.

Heating: The building's perimeter heating main

enters the room through the east wall and exits the room through the west wall. Pipes branch off to service a one-column, 18-section, ceiling hung, ornamental cast-iron hot-water radiator in the northeast corner of the room.

Lighting: One incandescent metal utility lighting fixture on the south wall; rigid conduit runs from the fixture through the east wall and into the exterior passage. Other electrical elements include a grounded duplex receptacle on the south wall, a 220-volt receptacle on the north wall, and a rigid conduit running from the exterior passage along the ceiling of Room B06 and up into Room 106.

Plumbing: One vitreous china toilet with the lid stamped "1 2812 90." One free-standing, enameled, cast-iron bathtub with ball-and-claw feet. A waste line runs from Room 106 down along the south wall and into the floor.

A pair of domestic water lines running from Room B05 enters the room through the east wall and is capped off near the west wall. A line branches off these pipes to service Room 106.

Other Features: Chromed soap dish and towel rack on west wall. Double-pronged hook in ceiling above bathtub. Pipe sleeve in north wall for a clothes dryer vent.

ROOM B07 REAR STAIR HALL

This long narrow hall is part of the basement of the rear addition constructed circa 1850 for Professor Harrison. As originally completed the finishes included a brick floor, whitewashed brick walls, and exposed ceiling framing covered in whitewash. There was a single small horizontal window opening at each end, two doors in the west wall, and a single door to the exterior in the east wall. A stairway to the first floor may have ascended at the north end of the passage.

Beyond the door in the east wall is an open passage under the connector, which joins the rear addition to the original 1819-23 pavilion. That space features the same finishes but is open, through two archways, to the exterior. At the east end of that passage is a doorway into the basement of the pavilion.

Modifications made to the hall in the early twentieth century include the installation of a plaster on wood lath ceiling and the present staircase. At a later date plaster on expanded metal lath was installed on the ceiling, and a small bathroom was constructed behind the staircase.

Floor: Original 7½" to 8¼"-long brick pavers. Evi-

PAVILION V



Room B07 Rear stair hall

dence of perimeter drain along north wall. This floor appears to be original, although the brick floor in the adjoining room (B08) is at a lower level.

Ceiling: Painted plaster on expanded metal lath, approximately 7' 0" above floor. Originally, circa 1850, the ceiling consisted of exposed wood framing which was whitewashed. Circa 1903/1929 a sawn wood lath and plaster ceiling was installed. Later this was replaced with the metal lath. Two later ceiling joists at the north end of the ceiling may represent the location for an earlier, possibly original, opening for a stairway from the first floor.

Walls: Multiple layers of paint over brick masonry. The painted finish extends above the line of the later finished plaster ceiling.

Doors: Two original door openings in the west wall with 2"-wide ogee surrounds (Type T-18). One original door opening in east wall. These openings date to circa 1850. Recent plain boards cover the original massive architrave of the east opening. One circa 1929 doorway in south wall, with plain 2 1/4" casing.

No. B071: A 1 3/4" thick solid core door. Hardware: Pair of 4 1/2" butt hinges, and a 2 1/4"-high "Schlage" brass mortise lock with pair of brass knobs. A 5" brass slide bolt is surface-mounted to the west face of the door. This recent door has been positioned in the circa 1850 opening.

Windows: One circa 1850 horizontal window opening in the north wall, recessed in wall and framed with a 2 1/4"-wide plain fascia trimmed with a bead around the opening, terminating on a plain 2 1/4" thick sill. The six-light horizontal awning sash hangs from the header on a pair of 2 1/4" steel or iron butt hinges, and fastens into the sill with an iron bolt and a more recent brass bolt on the bottom rail. The sash is old but has been modified. There are indications that the opening originally had a casement sash hinged to the west jamb.

Stairs: Plain, utilitarian open stringer stair with a straight run of eight treads to the first floor landing. The treads are 9 1/2" deep with a 1/2" nosing and 2' 10 1/4" wide. The risers are 10" high with a 1" nosing. A crude railing is formed of an elliptically shaped

ARCHITECTURAL DESCRIPTION

2"-high by 2½"-wide rail, supported by a 1½" by 2" post at the bottom of the stair. This staircase was constructed in the twentieth century, perhaps circa 1903 or later. Originally there was no stairway in this location. The space above the stair functioned as a closet. The original basement stair (if one existed) may have been located at the north end of the hall, where there is evidence that later joists were inserted in the ceiling.

Heating: A "Perfect" three-column, fourteen-section, cast-iron hot-water radiator sits below the north window. A large steel pipe runs through the west and east walls. Pipes branch off to run to the radiators in this room and in Room 109.

Lighting: An incandescent, metal utility lighting fixture is surface-mounted to the ceiling near the center of the room. Rigid metal conduit runs from a fuse box in the exterior vestibule to the lighting fixture. Conduits run from the light fixture to a double switch recessed into the west wall, to a grounded duplex outlet in the west wall, to the lighting fixture in Room B09, and up into Room 108. Other conduits from the fuse boxes in the exterior vestibule extend to the hot-water heater, to grounded duplex outlets on the east wall, to the washer/dryer outlets in Room B09, to the grounded duplex outlet in Room B08, and to the electrical light fixture in Room B07A.

Plumbing: An "A.O. Smith Glascote Mark III" hot water heater is located in the northeast corner of the hall. The hot-water heater is marked with "Serial No. H4469 1F06993, Model No. GED-80" and "80 gallons, max. 4500 watts, 240 volt." An abandoned domestic water line enters the hall above door B071 and runs along the east wall to the northeast corner of the hall, where remnants of old plumbing lines remain in the north wall. A waste line is embedded in the north end of the east wall. A pair of domestic water lines from the hot water heater extend east, branching off to run west into Room B09 and east to exit the building. A hot-water pipe runs through stairs from B07A and out through the east wall.

Equipment: A telephone cable from Room B08A runs up through the stair opening to the first floor.

Other Features: A floor-to-ceiling cabinet at the north end of the west wall was removed in 1992. The cabinet was 1' 6" deep by 6' 3" wide.

Paint Investigation: The brick walls retain at least 14 layers of cream/white whitewash with clearly defined dirt layers between each finish. The trim of the doorway to Room B08 has eight layers of finish including a deep brown, oil-like surface followed by

a deep green (2.5G2.5/2) finish. The fifth finish was a bright blue.

ROOM B07A BATHROOM

The creation of this bathroom may be contemporary with the construction of the stairway sometime in the first half of the twentieth century. This room occupies space that was originally the south end of the hallway.

Floor: Twentieth-century concrete. Remnants of 12" square vinyl tiles (removed in 1992) remain on the floor. This floor replaces the original brick surface, which can still be seen in the hall (Room B07).

Ceiling: Painted plaster on expanded metal lath 6' 7" above floor. This recent finish replaced the plaster on sawn wood lath that had covered the original whitewashed exposed framing.

Walls: The east, west, and south walls are original brick masonry with a skim coat of plaster and paint. The north partition and the base of the flight of stairs are covered with fiberboard.

Doors: One door opening in the north wall with 2½"-wide wood casing.

No. B07A1: A 1⅞" thick stile-and-rail door with two large recessed panels (Type D-6). Hardware: Pair of 3½" butt hinges, and a 5¼" brass mortise lock with pair of 7" escutcheon plates and brass knobs. A chromed towel holder is surface-mounted to the south face.

Windows: One original horizontal window opening in the south wall framed with a plain 2½" casing. A six-light casement sash is hung on a pair of 2½" iron or steel butt hinges from the east jamb. A small iron or steel slide bolt fastens into the sill. A metal pull is surface-mounted to the west stile.

Heating: The building's perimeter heating main enters the room through the stairs, turning to exit through the west wall into Room B09.

Lighting: One incandescent porcelain utility fixture. Rigid conduit runs from the ceiling-mounted fixture into Room B07.

Plumbing: The plumbing fixtures removed from this room in 1992 include: one "Trent" vitreous china toilet on the east wall, marked "6. 6. 69, 1400 CASE;" and one "Standard" enameled, cast-iron lavatory mounted to the west wall with a cast-iron bracket marked "Standard, 10½ B". An enameled, cast-iron bathtub on decorative cast-iron ball feet was positioned against the south wall. The lavatory and tub date to the early twentieth century and may have originally been placed here or moved here

PAVILION V

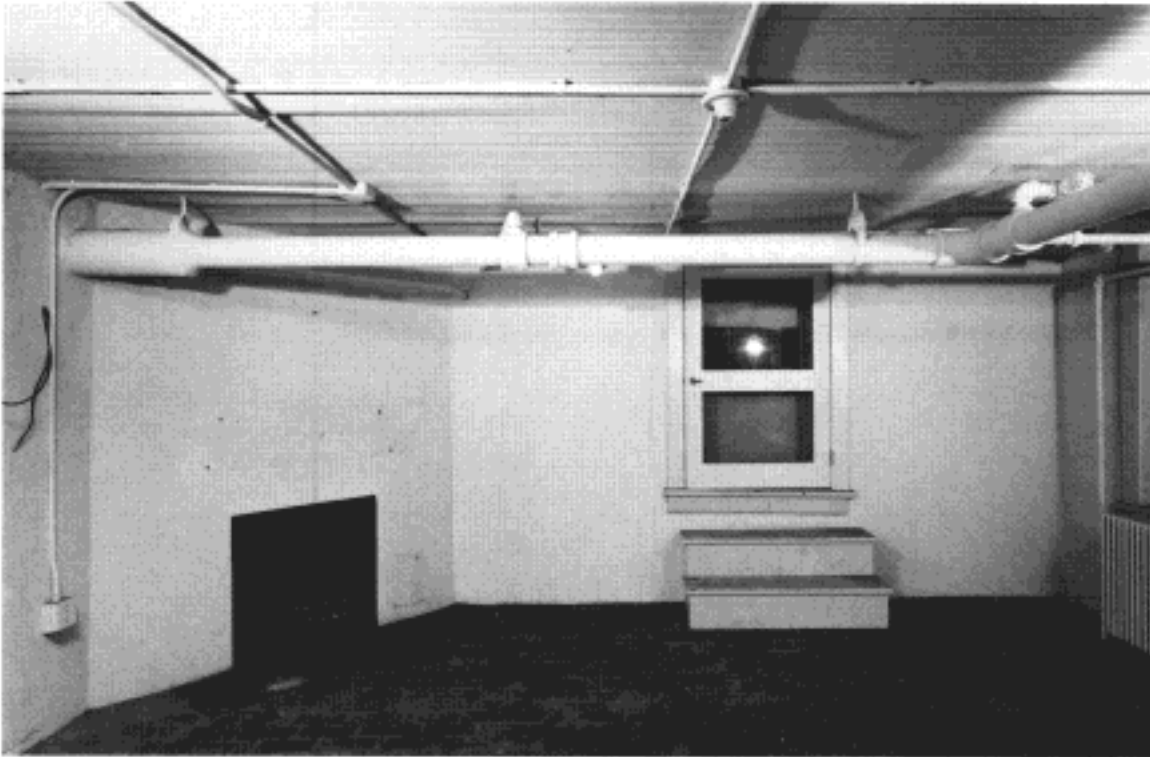

Room B08 Storage

from upstairs when the second floor bathrooms were remodeled.

A waste line enters the room through the east wall, extending to the lavatory on the west wall, and down into the floor.

Other Features: Bathroom accessories removed in 1992 include shelves and a chromed towel rack on the west wall and a chromed shower curtain rod suspended from the ceiling.

ROOM B08 STORAGE

The function of this room at the time of its completion, circa 1850, is unknown. At that time the room included three windows (smaller than the current openings), a brick floor, and a fireplace in the southwest corner. The ceiling consisted of the exposed framing of the first floor. The room may have been converted into a kitchen when the pavilion was jointly occupied by Professors Smith and Kent in 1903. Part of the circa 1903 renovations may have included the installation of a plaster on sawn wood

lath ceiling here. Later, when the windows were modified, the beaded board ceiling was placed over the plaster surface. It is possible that the plaster ceiling is an earlier addition and that the beaded boards date to circa 1903.

Later in the twentieth century the kitchen was moved upstairs to Room 108.

Floor: Original brick floor approximately 7 $\frac{1}{4}$ " to 8 $\frac{1}{4}$ " by 3 $\frac{1}{2}$ " to 3 $\frac{3}{4}$ " pavers laid in a running bond in a north/south direction with one soldier course along the south wall.

Ceiling: Narrow beaded boards, running north/south, approximately 7' 0" above the floor. Sheet-metal patches have been made along north and east walls around plumbing and electrical lines. The ceiling finish covers an earlier, possibly circa 1903, ceiling of plaster on sawn wood lath. There is no evidence of whitewash on the ceiling framing.

Walls: Plaster on original brick masonry. The walls were probably originally of bare or white-washed brick, which was later covered in plaster (circa 1903) and painted.

ARCHITECTURAL DESCRIPTION

Doors: One original door opening in the east wall with a 3½" single-fascia architrave surround (Type T-19). Its massive wood threshold was removed in 1992. A door has been inserted in a window opening in the west wall; the opening has a plain 5½"-wide casing.

No. B081: An original 1⅛" thick stile-and-rail door with four recessed panels (Type D-9). Hardware: Original pair of 3" iron butt hinges and a nineteenth-century wrought-iron thumb latch. An early iron hasp fits over a staple in the north jamb. There is evidence on the lock rail for an original 5½" by 8" box lock.

No. B082: A twentieth-century 1⅛" thick stile-and-rail door with a glazed panel above a recessed panel (Type D-10). Hardware: Pair of 3" butt hinges, a 2¼" brass "Schlage" mortise lock with brass knobs and a wood escutcheon plate, and a "Kwikset" brass deadbolt.

There is a 1⅛" thick stile-and-rail door with two screened panels on the exterior face of the opening. Hardware: Pair of 3" brass hinges and a brass mortised latch.

Windows: Two window openings in the north wall. Each window is framed with a plain 5½"-wide fascia casing on the sides. The northeast window has a ½" header, while the northwest window has no header. The architrave of the northeast window terminates on a 1½" thick sill and 4"-high apron with a flush bead at the bottom edge, and the architrave of the northwest window terminates on a ¾"-thick sill and 4"-high apron with a flush bead at the bottom edge. The 6/6 sash have 10" by 12" panes, ⅙" muntins, and a sweep thumb latch on the meeting rails. All three original window openings (including the opening converted into a doorway in the west wall) were modified and enlarged in the early twentieth century. The trim, which is contemporary with the beaded board ceiling, was installed when the windows were enlarged.

Fireplace: The original brick chimney breast extends diagonally across the southwest corner of the room and is approximately 6' 1" wide. There is evidence of a 1' 0"-high, 5' 0"-wide mantle shelf above the 2' 3½"-wide by 2' 7"-high opening. A 4' 5"-wide brick hearth, with 7½" to 8"-long by 3½"-wide bricks projects 1' 3½" from the chimney breast. The firebox was rebuilt and modified, and the hearth was reworked in the twentieth century.

Heating: One six-column, 19-section, cast-iron, hot-water radiator sits below the northwest window. The radiator is marked "National [Art?] Radiator."

A large steel pipe runs from Room B09 turning east into Room B07. One pipe branches off to service the radiator, and a pair of pipes branches off to run into the west wall; another branch line services the radiator in Room 109. Piping is routed along the base of the north wall, interconnecting the radiators in Room B08 and Room B07.

Lighting: A porcelain utility fixture is mounted to a junction box near the center of the ceiling. Rigid metal conduit runs from the lighting fixture to duplex receptacles on the east and north walls, to Room 110, to Room B09, and to a second porcelain utility fixture near the west wall and up to Room 110. Other conduits run from a junction box on the ceiling near the south wall to a grounded duplex outlet on the south wall, to Room B09, and up into Room 110.

Plumbing: None.

Equipment: A telephone jack is surface-mounted to the architrave of the northeast window; station wire runs out through the architrave of door B081 into the hall (Room B07).

Other Features: A floor-to-ceiling built-in cabinet was removed from the south wall in 1992. The cabinet was 5' 6" wide.

Paint Investigation: The pink sandy plaster ceiling surface, now covered by the beaded boards, was originally painted in a bright yellow/gold color to which a red/brown finish was applied. The latter layer is very soiled and deteriorated.

The original door trim and door were initially finished in a deep brown oil-like finish followed by a deep green (2.5G2.5/2) finish. The earliest finish layer on the window trim is the same deep green.

ROOM B09 STORAGE

Unlike the ceilings in the adjoining room (B08) and hall (B07), which originally had no plastered finish, the ceiling in this room has always had a rough plastered surface. The plastered ceiling indicates that this room had some special function; perhaps the space was occupied by a servant.

The room retains two of the small window openings that were originally duplicated at the other openings of the rear addition.

Floor: Twentieth-century concrete. The finished surface of the concrete is about 1" higher than the original brick floor in the hall. The concrete was probably used to cover or replace an earlier brick floor paving.

Ceiling: Original brown coat of plaster over split-

PAVILION V

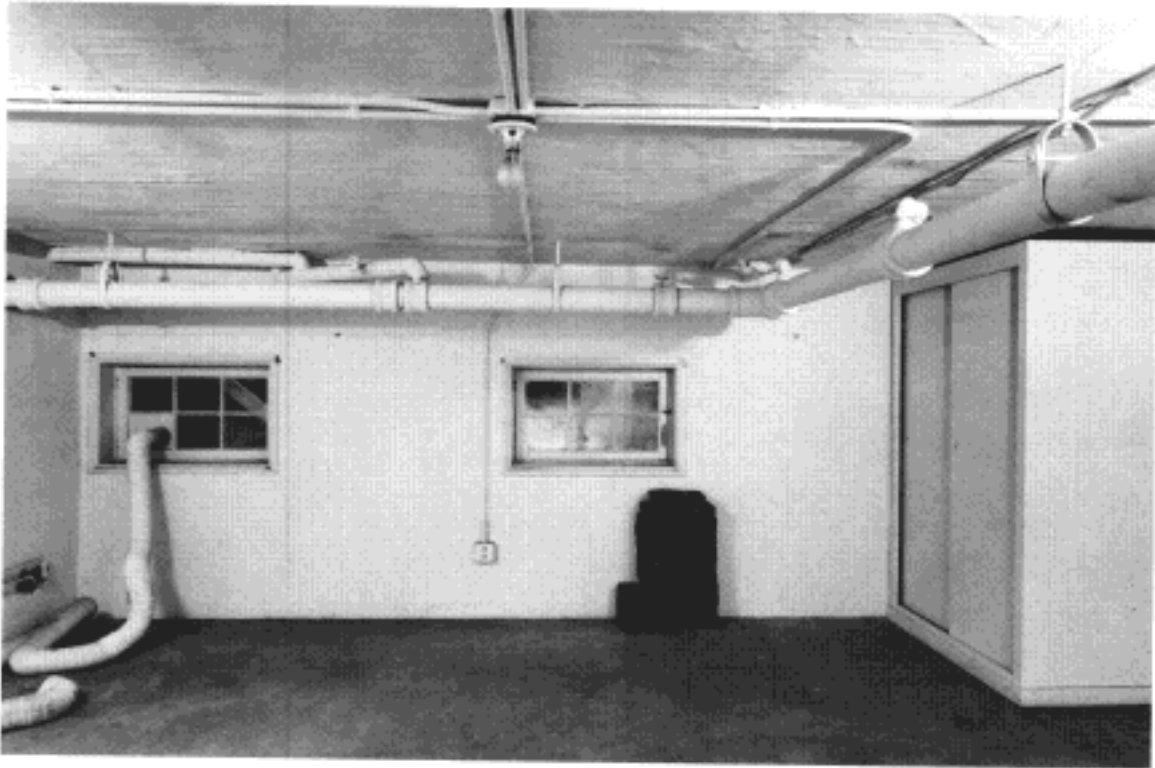

Room B09 Storage

wood lath 6' 5" above the floor. The surface is covered in layers of whitewash and paint.

Walls: Plaster and paint on original brick masonry. There are areas of repaired plaster.

Doors: One original door opening in the east wall with a 3½"-wide single-fascia architrave surround (Type T-19).

No. B091: Original 1¼" thick stile-and-rail door with four recessed panels (Type D-9). Hardware: Pair of later 3" butt hinges, a brass "Kwikset" dead-bolt, and a metal pull. A wire hook-and-eye and a plastic laundry accessory rack are mounted to the west face. There is evidence on the lock rail for earlier box locks.

Windows: Two original windows in the south wall are framed on all four sides with original 1¾"-wide molded architraves composed of an ogee and fillet molding (Type T-14). Each window has a six-light casement sash with 10" by 8" panes and ⅝" muntins; each sash is hung from the east jamb on a

pair of 2" iron or steel butt hinges. The sash are fastened with small iron bolts. The southwest window has a small metal pull. A metal sleeve, used to vent a clothes dryer, has been inserted into a pane of the southeast sash. These windows represent the original condition of the windows circa 1850; the casement sash may be replacements but the openings originally held similar casements.

One modified window in the west wall is framed with a plain 5½" architrave terminating on a plain sill and an apron with a flush bead at the bottom edge. The 6/6 sash (no ropes or chains) have 10" by 12" panes, ⅝" muntins, and a sweep thumb latch attached to the meeting rails. This window was enlarged in the early twentieth century. The simple trim is contemporary with the window trim in Room B08.

Fireplace: The original brick chimney breast extends diagonally across the northwest corner of the room. It is approximately 6' 3" wide. There is no

ARCHITECTURAL DESCRIPTION

mantlepiece above the 2' 0"-high by 2' 6"-wide fire-box opening. A 4' 2"-wide brick hearth projects 1' 7" from the chimney breast. The fireplace was probably reconstructed in the twentieth century.

Heating: The building's perimeter heating main runs through east wall, along south wall, turning to run north into Room B08. Pipes branch off to service the radiator in Room 110 and exit the room through the south and east walls.

Lighting: Porcelain utility fixture mounted to junction box near center of ceiling. Seven rigid conduits extend from this fixture: one runs to a grounded duplex outlet on the south wall; two run east to Room B07 and up to Room 110; two run west and up to Room 110; and two run north, one into B08 and another up to Room 110. Other electrical components include grounded duplex outlets on the north and west walls; a 220-volt receptacle and a grounded duplex receptacle on the east wall are

both serviced by rigid conduit from Room B07 (for washer/dryer).

Plumbing: Water lines suspended from the ceiling run from Room B07 to the chimney breast, where they are capped off. Two lines branch off to run along the east wall to the southeast corner (for washer) and into B07A. There are small copper water lines and a waste line in the east wall.

Other Features: One 6' 2½"-tall plywood closet in the southwest corner of the room. The closet is 2' 2½" deep by 3' 11" wide.

Paint Investigation: The pink sandy plaster wall surface is covered with approximately 11 layers of a whitewash and a more recent bright yellow paint, which is covered by the current cream-colored paint. The trim of the doorway in the east wall was first covered with a brown, oil-like finish followed by the same deep green (2.5G2.5/2) finish used in Rooms B07 and B08.



T-30

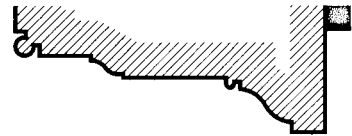

T-35



T-31

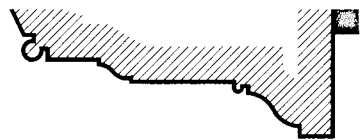

T-36



T-32

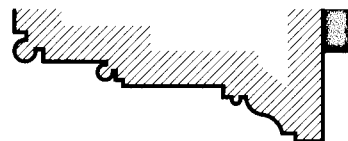

T-37

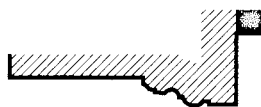

T-33

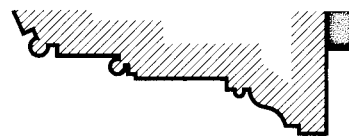

T-38



T-34

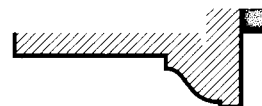

T-39

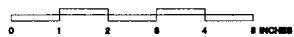

ARCHITECTURAL DESCRIPTION

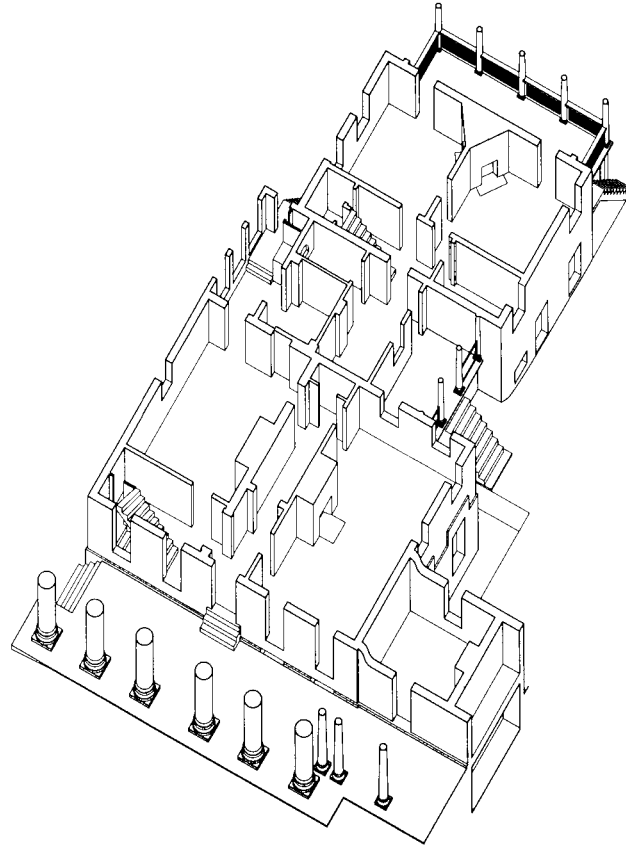

FIRST FLOOR

The first floor plan of this pavilion duplicates that of Pavilion I in both layout and overall size. It is only in the details that the various rooms differ.

As originally planned and used, the first floor had a long, narrow central hall that extended from the front to the rear of the pavilion. This passage served both the professor in residence and the students. The large lecture room was located to the right, or north, of the entrance hall. A doorway in the south wall of the entrance hall opened into a stair hall, and that in turn opened into a room that functioned as a dining room or study. These two rooms formed the private domain of the professor on the first floor. Additional rooms intended for the professor's private quarters included the basement kitchen and the second floor parlor and bed-chambers. As the university grew, the lecture room was no longer needed and became part of the professor's residence.

PAVILION V

The expansion of the pavilion circa 1850 by Professor Harrison increased the first floor area by almost two thirds. The added spaces included a connecting corridor or hyphen as well as a rear stair hall and two large bedchambers.

No other significant changes were made to the first floor until the early years of the twentieth century, probably circa 1903/1929, when the pavilion was modified to function as two separate residences. The work involved the expansion of the circa 1850 connector that joins the front and rear parts of the structure. A formal entrance to the rear building was added to the north side of the connector. Additional spaces, including a room with impressive arched windows, were constructed on the south side of the connector. The original portion of the pavilion was significantly altered by the creation of the arched opening between the entrance hall and the stair hall.

In circa 1929 a covered porch was added to the back of the rear addition. A twentieth-century toilet room was installed at the west end of the pavilion's central hall.

ARCHITECTURAL DESCRIPTION

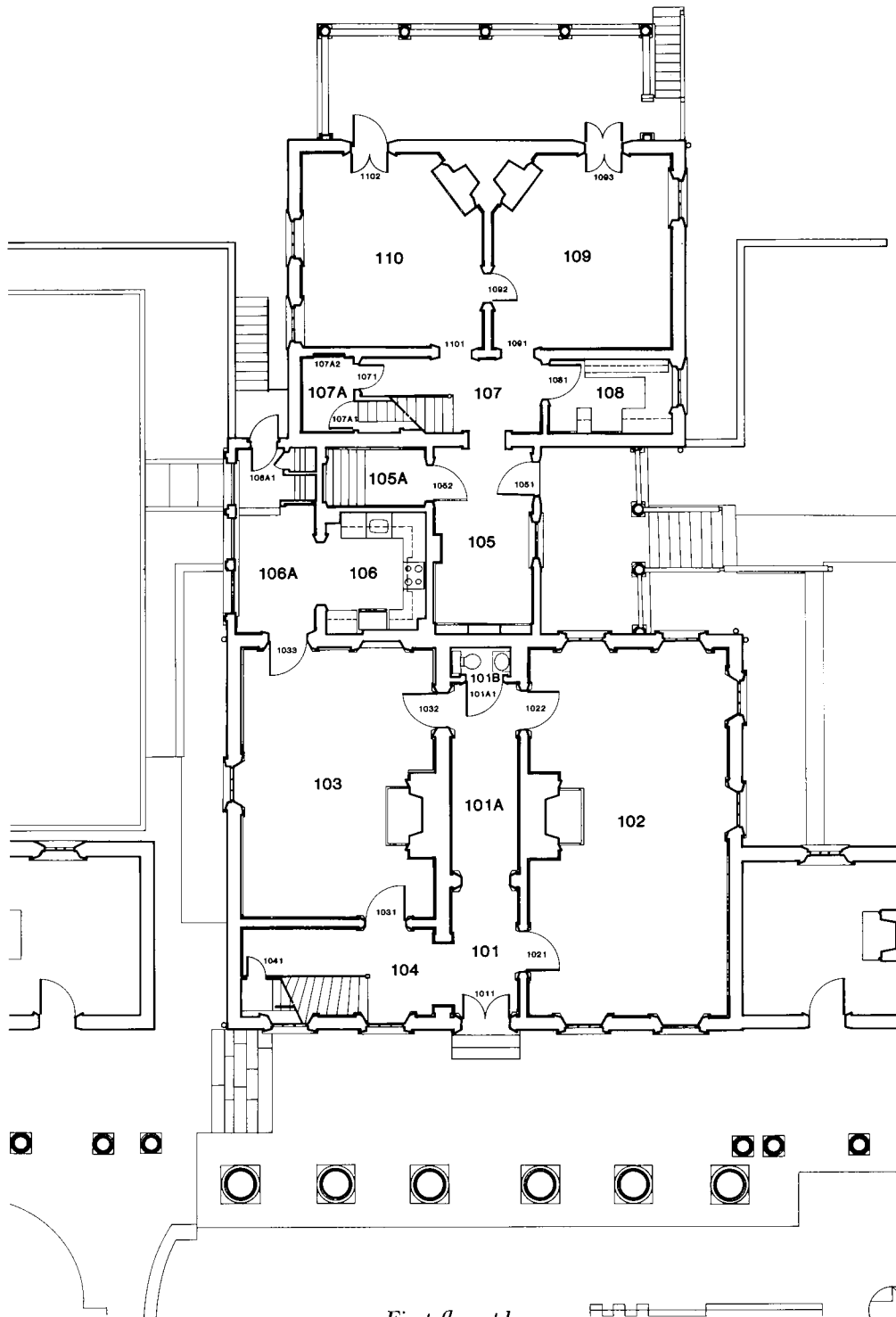

First floor plan

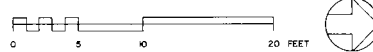

PAVILION V

ROOM 101 ENTRANCE HALL

The small rectangular entrance hall provides access into the living room (former lecture room) on the north and to the stair hall on the south.

The small size and general appearance of this hall dates to the twentieth century. Originally the hall extended fully through the center of the pavilion from the front entrance to the rear (west) garden entrance. This arrangement is shown on the Jefferson floor plan, as well as on the plan drawn by Cornelia Jefferson Randolph or John Neilson (Randolph-Neilson plan).

The twentieth-century modifications include the elaborate arched opening in the south partition. This impressive feature may have been added as part of the work undertaken circa 1903 when Professor Smith occupied the Pavilion. The arch replaced a doorway that matched the one still in place in the north wall.

The original long hall was shortened when an opening with a glazed transom was installed forming a division between the east and west ends of the space. This insertion may date to work undertaken in 1929, or it may be of more recent origin.

Surviving original architectural finishes include the front entrance doors and architrave, the doorway opening to Room 102, and the cornice, chair rail, and baseboard. In its original form this hall appeared much like the extant hall in Pavilion I.

Floor: Random-width (4¼" to 5½") tongue-and-groove boards, running east-west. The boards may be original.

Ceiling: Painted plaster, 11' 10½" above floor.

Walls: The north wall is original plaster-on-wood lath. The east and south walls are plaster on original masonry. The south wall was disturbed when the archway was inserted, possibly circa 1903. The west partition is a twentieth-century insertion constructed of plaster on lath.

Baseboard: 9¼"-high baseboard, including a 6" splashboard with a 3¼" molded top along the north, south, and east walls (Type B-1). There is no baseboard on the west wall. All baseboards are original.

Chair Rail: Original 3½"-high molded wood rail (Type T-40).

Cornice: 11½"-high painted, unornamented wood cornice (Type C-3). All of the cornice is original except for the section along the west partition that dates to the twentieth century.

Doors: Two doorways with painted wood surrounds. The two-leaf entrance door in the east wall



Rooms 101 and 101A Entrance hall

has a two-fascia architrave surround (Type T-21) and a rectangular transom with eleven lights formed by semicircular and radiating muntins. Both leaves of the door are painted and grained to resemble mahogany on the interior face and painted deep green on the exterior. The door to the north leading to Room 102 is painted white and has a two-fascia architrave surround (Type T-22). Both of these openings and the doors are original.

Neither of the two additional door openings in the hall has a door. The large, arched opening in the south wall leads into the front stair hall (Room 104) and is trimmed with fluted pilasters supporting a single-fascia architrave. A wood, molded keystone trims the crown of the arch. The wood reveal of the arch is trimmed with recessed panels. This opening may have been created circa 1903 and replaced a doorway identical to door 1021. The opening in the west partition was installed much earlier, perhaps in 1850; details of the original exterior entrance at the east end of the central hall were copied.

No. 1011: Pair of original 1¾" thick stile-and-rail leaves, each with three raised panels (Type D-11).

ARCHITECTURAL DESCRIPTION

Hardware: Each leaf has an original pair of iron butt hinges. The right leaf retains the original upper and lower iron slide bolts. The 4" by 6" iron and brass box lock was installed in the twentieth century. There is evidence on the south leaf for the original 6"-high box lock keeper.

Lighting: No artificial lighting remains in the hall. A circular plate on the north wall marks the location of a former wall fixture (removed in 1992). One duplex receptacle in baseboard.

Paint Investigation: The hall in its original configuration included the following finishes: the wood trim, including the architraves, cornice, chair rail, and baseboard, was covered in a yellowish white (2.5Y9/2) paint. The top surface of the chair rail and the vertical face of the base were painted in a reddish brown (10R3/2). The paneled doors were finished in a mahogany graining. The plaster walls retain slight evidence of a very light grey (5Y8.5/1) water-based paint followed by the application of wallpaper.

ROOM 101A HALL

This hall is now completely enclosed, but prior to the nineteenth- and twentieth-century modifications it was opened to the exterior through the original entries at the east (front) and west (rear) ends of the space.

The Jefferson floor plan and the Randolph-Neilson plan do not include the present doorways at the west end of this hall that open into Rooms 102 and 103. The Maverick plan (1822) does include the two doorways, and physical evidence indicates that they are original features. The creation of the small toilet room at the west end of the hall and the insertion of the partition at the east end appear to be concurrent twentieth-century modifications.

Floor: Random-width (4¼" to 5½") tongue-and-groove boards, running east-west. The boards may be original.

Ceiling: Painted plaster, 11' 10½" above floor.

Walls: The north wall is original plaster-on-wood lath. The south wall is plaster on original brick masonry. The east and west partitions of plaster on lath are nineteenth and twentieth-century insertions.

Baseboard: Original 9¼"-high baseboard, including a 6" splashboard with 3¼" molded top, along north and south walls (Type B-1). A plain 7"-high splashboard exists on the east partition and a replica of the original baseboard is in place on the west partition. The latter two baseboards date to the twenti-

eth century.

Chair Rail: Original 3½"-high molded wood rail (Type T-40). Short sections of rail on the west partition were installed in the twentieth century.

Cornice: 11½"-high painted, unornamented wood cornice (Type C-3). The section along the west partition is original but was formerly located on the west wall of Room 101B, the original end of the hall.

Doors: Three door openings with painted wood surrounds. The two doors in the north and south walls are painted white; each has a two-fascia architrave surround (Type T-22). The third doorway dates to the twentieth century, when Room 101B was constructed. The east face of the door is painted white, and the west face is painted metallic gold. The door is framed with a two-fascia architrave surround (Type T-FF).

A nineteenth-century door frame to the east separates Room 101A from Room 101. The frame appears to be a copy of the original exterior entrance in the east wall, with a two-fascia architrave (Type T-24) and a rectangular transom with eleven lights formed by semicircular and radiating muntins. Although a wood stop has been installed to accommodate a door within this frame, there are no hinge marks to indicate that a door was ever placed here.

No. 101A1: 1½" thick stile-and-rail door with six raised and beveled panels (Type D-12). This door, an original feature of the pavilion, dates to 1819-23 and was formerly located on the second floor. Hardware: Pair of 4" butt hinges and a 5¼"-high brass or bronze mortise lock stamped "P 10." Each side has a brass or bronze 7" escutcheon plate and 2¼" diameter knob. This hardware dates to the twentieth century. There is evidence that the door originally had a mortise lock and small escutcheon-type keyhole covers.

Lighting: No artificial lighting remains in the hall. Electrical wiring and junction boxes remain in the north and south walls for two wall fixtures (removed in 1992). Two duplex receptacles in baseboard.

Paint Investigation: The paint evidence found here is the same as described for the entrance hall (Room 101).

ROOM 101B TOILET ROOM

This small toilet room was created in the twentieth century from what was formerly the west end of the central hall. The doorway in the west wall originally

PAVILION V

opened to the exterior and the garden beyond. After the circa 1850 rear addition was constructed, the door opened to the connecting passage between the two buildings. When the toilet room was created, the door opening and the adjoining wall were covered over by a partition formed of plaster on expanded metal lath.

Floor: Random-width (4¼" to 5½") tongue-and-groove boards, running east-west. This flooring appears to be original.

Ceiling: The twentieth-century plaster on expanded metal lath ceiling for Room 101B has been removed, revealing the original split lath, 11' 11" above the floor. The more recent ceiling was 7' 11½" above the floor.

Walls: The north, south, and west walls are original plaster on masonry (south and west) and lath (north). The east wall is plaster on expanded metal lath. Before the bathroom was dismantled in 1992, the west wall was plaster on expanded metal lath, furred out from the original west wall approximately 3".

Baseboard: The original 9¼"-high baseboard, including a 6" splashboard and a ¾" molded top (Type B-1), runs along the north, south, and west walls. A twentieth-century 5½"-high splashboard runs along the east wall.

Chair Rail: The original 3½" molded rail (Type T-40) runs along the west wall. The chair rail has been removed from the north and south walls.

Cornice: The original 11½"-high painted, unornamented wooden cornice (Type C-3) runs along the north and south walls at the height of the original ceiling. The south cornice is mitered at the west wall, while the north cornice has been cut off to allow for plumbing risers. The cornice has been removed from the west wall; apparently it was moved to the east face of the partition dividing 101B from 101A.

Doors: The door opening in the east partition dates to the twentieth century. The six-panel door is painted white on its east face and metallic gold on its west face and is framed with a plain, 4" wood fascia. The door is an original feature of the pavilion and was formerly located on the second floor.

The opening for the original exterior door remains in the west wall. The opening is framed with a two-fascia architrave (Type T-21) and has a rectangular transom with eleven lights formed by semicircular and radiating muntins.

No. 101B1: The original rear door, which is missing, apparently had a box lock; there is evidence of

the keeper on the architrave. The six-panel door most recently fitted to this opening appears to be the original door from the opening between the second floor stair hall (Room 201) and the hall (Room 202). The door was made narrower to fit the current opening. Hardware: The door retains evidence of original hardware consisting of a 4¾"-high mortise lock.

Lighting: There is no artificial lighting existing in this room. A flexible armored cable runs through the north wall to a junction box that served a ceiling fixture until the room was dismantled in 1992.

Plumbing: An enameled cast-iron lavatory, marked "11 4 63 4300 12 x 17 Baltimore" and "Made in United States of America by American Radiator & Standard Sanitary Corporation," and an "American Standard" vitreous china toilet were removed from the room in 1992.

The remaining plumbing lines include a copper drain line in the northwest corner of the room, copper hot- and cold-water lines supplying the lavatory at the north end of the room, a water line to the toilet at the south end of the room, and a cap indicating the location of the waste line.

All of this plumbing was installed in the twentieth century.

Paint Investigation: The paint evidence found here is the same as described for the entrance hall (Room 101).

ROOM 102 LIVING ROOM (ORIGINAL LECTURE ROOM)

This large, finely proportioned room is very much like the original lecture room in Pavilion I. It is not known when this impressive room was incorporated into the professor's living quarters. The doors in the south wall give access to the east and west portions of the original central hall. Six original windows provide ample natural light.

All of the architectural finishes are original except the mantelpiece, which was installed in the twentieth century. The appearance of the fireplace prior to this installation remains unknown.

Neither the Jefferson nor the Randolph-Neilson floor plans shows the doorway in the south wall located west of the chimney breast, but the doorway is shown on the Maverick plan of 1822.

Floor: Random-width tongue-and-groove boards, running north-south, stained and varnished. This flooring is probably original.

ARCHITECTURAL DESCRIPTION



Room 102 Living room

Ceiling: Painted plaster on lath, approximately 11' 11" above the floor.

Walls: The north, east, and west walls are plaster on original brick masonry, while the south wall is plaster on wood lath. All of these surfaces are original, although a skim coat of twentieth-century plaster has been applied to some surfaces.

Baseboard: Original 8 $\frac{1}{4}$ "-high baseboard, including a 6" splashboard with a 2 $\frac{1}{4}$ " molded top (Type B-2).

Chair Rail: Original 3 $\frac{1}{2}$ "-high wood rail (Type T-40).

Cornice: Original 11"-high unornamented wood cornice, painted (Type C-3).

Doors: Two original door openings in the south wall with two-fascia architrave surrounds (Type T-22).

No. 1021: Original 1 $\frac{1}{2}$ " thick stile-and-rail door with six raised panels (Type D-13). Hardware: Original pair of 5" iron butt hinges and a circa 1929 5 $\frac{1}{4}$ "-high bronze mortise lock stamped "P 10." Each side has a bronze 7" escutcheon plate and 2 $\frac{1}{4}$ " diameter knob. Evidence indicates that the door originally

had a 4 $\frac{1}{2}$ " by 7" iron or brass cased box lock with brass knobs (a 2" rose) and a keyhole escutcheon on the south face.

No. 1022: Original 1 $\frac{1}{2}$ " thick stile-and-rail door with six raised panels (Type D-13). Hardware: Original pair of 5" iron butt hinges and a circa 1929 5 $\frac{1}{4}$ "-high brass or bronze mortise lock stamped "P 10." Each side has a bronze 7"-high escutcheon plate and 2 $\frac{1}{4}$ " diameter knob. There is evidence for two differently sized box locks: a 4 $\frac{1}{2}$ " by 7" box lock and a 5 $\frac{1}{2}$ " by 9 $\frac{1}{4}$ " box lock. The 4 $\frac{1}{2}$ " by 7" lock was probably the earliest.

Windows: Two original windows in the north wall and two original windows in the west wall with splayed, paneled reveals at the sides and head and a paneled apron. Above the molded sill the reveals are divided at the level of the meeting rails and each portion has a tall, thin rectangular panel with a small square panel above. Each window is framed with a 6 $\frac{1}{2}$ "-wide two-fascia architrave terminating at splashboard-height plinths, and has a 6/6 double rope-hung sash with 12" by 18" panes, $\frac{1}{16}$ " muntins,

PAVILION V



Room 102 Living room

and a recent sweep thumb latch on the meeting rails. A new stop bead has been installed at the east window.

Two original windows in the east wall with splayed, plain reveals and a $6\frac{1}{2}$ " two-fascia architrave surround, terminating at splashboard-height plinths. Each window has 6/6/6 triple rope-hung sash with 12" by 18" panes, $\frac{3}{16}$ " muntins, and a recent sweep thumb latch on each of the meeting rails.

Fireplace: The original 7' 2"-wide chimney breast projects 2' 8" from the south wall. The brick-lined firebox is painted glossy black, and its brick surround is painted matte black. The surround is bordered in turn by an $8\frac{1}{2}$ " two-fascia architrave molding. Above the architrave is a plain $5\frac{1}{2}$ " frieze and a $7\frac{1}{2}$ " denticulated cornice. The wooden mantel is a reproduction, probably installed in the 1950s. The method of construction and lack of paint layering on the mantel confirms the recent origin of this fitting. The bricks of the firebox are approximately $2\frac{3}{4}$ " by 9" by 4".

Heating: One three-column, eighteen-section, cast-iron hot water radiator, marked "American Radiator" and "Peerless," is located between the east windows. A three-column, 11-section, cast-iron hot-water radiator with eleven sections is marked "USR-CORP" and is located below the northwest window. A pair of floor-to-ceiling heating pipes in the northwest corner of the room services the radiator in Room 204, while a pair of floor-to-ceiling heating pipes in the southeast corner of the room services the radiator in Room 203.

Lighting: There are no electrical lights in this room. A switch with a plastic switch plate is on the wall south of door 1021, and there are nine duplex receptacles in the baseboard and a 220 volt receptacle in the east wall immediately west of the window. A circular metal plate mounted on the south wall between the chimney breast and door 1021 marks the location of an earlier wall fixture.

Paint Investigation: Traces of original finishes were found on the various surfaces in this room. The woodwork, including the cornice, was originally

ARCHITECTURAL DESCRIPTION



Room 103 Dining room

covered in a yellowish white (2.5Y9/2) paint. The top surface of the chair rail and the vertical face of the baseboard was finished in a reddish brown (10R3/2) paint. Only minute traces of early finishes were found on the plaster walls, including a bright yellow (5Y9/6) and a purple blue (7.5PB8/2-5PB7/4). Fibers of early wallpaper were also found on the plaster. The two doors were grained to imitate mahogany.

The reproduction mantel is covered in three finishes of cream and white paint.

A comparison of paint layering on the architraves of the two doors revealed that the east opening (door 1021) had eleven-plus layers of finish while the west opening (door 1022) had only five finishes. This may indicate that the west opening is a later insertion as the Jefferson floor plan suggests. The door itself is of the 1819-23 period, and may in fact be the door originally located in the opening between the entrance hall (101) and the stair hall (104). The archway replaced that opening, perhaps circa 1903.

ROOM 103 DINING ROOM

This large room, an original part of the professor's private living quarters, was designed to serve as the professor's study, but it also functioned as a dining room. Jefferson's plan does not include the doorway in the north wall, which provides access to the west end of the central hall. The Randolph-Neilson plan also omits this door and shows two windows in the south wall rather than the single window that exists today. The 1822 Maverick plan does include the northwest door as it exists today, but that plan also illustrates two windows in the south wall.

Physical evidence indicates that the current arrangement is the original condition.

At least one, and probably both, of the two original window openings in the west wall was converted into doorways when the rear, circa 1850 addition was enlarged circa 1903/1929.

Almost all of the original architectural finishes survive in this important room, including the wooden mantel.

PAVILION V



Room 103 Dining room

Floor: Random-width tongue-and-groove boards, running north-south, stained and varnished. The flooring is probably original.

Ceiling: Painted plaster, 11' 10½" above floor.

Walls: The north, south, and west walls are original plaster on brick masonry. The west wall was originally an exterior wall. The east wall is original plaster on wood lath.

Baseboard: Original 9¼"-high baseboard, including a 6"-high splashboard with 3¼" molded top (Type B-1).

Chair Rail: Original 3½"-high wood rail (Type T-41).

Cornice: Original painted wood cornice, approximately 11½" high (Type C-3).

Doors: One original door opening in the north wall and one original door opening in the east wall, with two-fascia architrave surrounds (Type T-22). A third door has been inserted in an original window opening in the west wall. A wood panel with four raised panels has been inserted above the door to fill in the opening, which is framed by a two-fascia

architrave surround (Type T-23).

No. 1031: Original 1¼" thick stile-and-rail door with six raised panels (Type D-13). Hardware: Original pair of 5" iron butt hinges and a circa 1929 5¼"-high brass or bronze mortise lock stamped "P 10." Each side has a brass or bronze 7" escutcheon plate and 2¼" diameter knob. Evidence reveals that this door originally featured a 5"-high mortise lock.

No. 1032: Original 1¼" thick stile-and-rail door with six raised panels (Type D-13). Hardware: Pair of later 3½" butt hinges and a circa 1929 5¼"-high brass or bronze mortise lock stamped "P 10." Each side has a brass or bronze 7" escutcheon plate and 2¼" diameter knob. A brass hook has been attached to the south face of the door. The door was originally hinged to the east jamb and featured a 5"-high mortise lock.

No. 1033: A twentieth-century 1¼" thick stile-and-rail door with four raised panels (Type D-15). Hardware: Three 6" spring hinges, 3" by 1' 0" chrome push plates, and a foot-operated door stop.

Windows: One original window in the south wall

ARCHITECTURAL DESCRIPTION

with splayed, paneled reveals at the sides and head, a paneled apron, and molded wood sill at the height of the chair rail. Above the sill, the reveals are divided at the level of the meeting rails and each portion has a tall, thin rectangular panel with a small square panel above. The window has a 6½"-wide two-fascia architrave surround (Type T-23) terminating on splashboard-height plinths, and 6/6 double-hung wood sash with 12" by 18" panes, ⅛" muntins, and a recent sweep thumb latch on the meeting rails. A new stop bead has been installed along the east edge of the window.

The paneled reveals and heads of two additional windows remain in the west wall. The northwest window has been filled in with plain wood panels and shelves. Above the shelves, raised paneling has been inserted to fill the remainder of the opening. Prior to the installation of the shelving this opening may have been a doorway dating to circa 1903. The other former window opening has been converted to a doorway (No. 1033).

Fireplace: The original 7' 1"-wide chimney breast projects 2' 4" from the north wall. The brick-lined firebox is painted black. Two of the bricks at the back of the firebox are cast with "Powhatan Clay Mfg. Co., Richmond Va."; the bricks on the floor of the firebox are cast with "Penn." An original mottled black marble surround rests on white marble plinths. The marble is bordered by an 8½"-wide two-fascia architrave molding, topped by a 5¼" plain fascia and a 7¼" denticulated cornice. This mantle is original.

Heating: A three-column, ten-section, ornamental, cast-iron, hot-water radiator is located below the south window. A similar radiator with 12 sections is set between the west door and the old northwest window opening. Neither of these radiators has any visible manufacturer's marks.

Lighting: There are currently no lighting fixtures in the room. A circular metal plate on the north wall east of the chimney breast marks the location of a previous lighting fixture. One electrical junction box in the north wall and four in the south wall serviced twentieth-century wall fixtures that have been removed recently.

Other electrical features include a switch with a plastic switch plate in the east wall south of door 1031, three duplex receptacles in the baseboard, and a 220 volt receptacle in the south wall immediately east of the window.

Plumbing: Copper tubing extends from the basement through the floor and through the west wall.

The tubing was used to supply water to an icemaker in the kitchen (Room 106).

Other Features: There are seven shelves in the original northwest window opening. The shelves are ¾" high by 11" deep and date to the twentieth century.

A "General" carbon dioxide fire extinguisher is hung from a bracket screwed to the chair rail at the west end of the north wall.

Paint Investigation: Traces of original finishes were found on the various surfaces. The woodwork, including the cornice and mantel, was originally covered with a yellowish white (2.5Y9/2) paint. The top surface of the chair rail and the vertical face of the baseboard were finished in a reddish-brown (10R3/2) paint. The plaster walls were covered in wallpaper of which only minute traces were found. The two original doors were grained to imitate mahogany.

The panel above the doorway (formerly a window) in the west wall is covered in three layers of cream and white paint.

ROOM 104 FRONT STAIR HALL

The stair hall originally provided access to the professor's private quarters on the first and second floors and in the basement. The door in the west wall opened into the professor's study and dining room.

Originally, a doorway separated this stair hall from the entrance hall. The broad arched opening replaced the doorway, perhaps circa 1903. This open arrangement would not have been suitable when the large north room (102) functioned as the lecture room.

All of the original finishes survive here, except for those associated with the replacement of the original doorway in the north wall.

The stair hall follows the configuration shown on the Jefferson and Randolph-Neilson drawings, except for the plan of the staircase. The stairs shown on the two original drawings are arranged in two different manners, and neither includes the angled treads of the stair as actually constructed.

Floor: Random-width tongue-and-groove boards, running north-south, stained and varnished. The flooring is original.

Ceiling: Original plaster, painted. At the north end of the hall the ceiling is 11' 10¼" above the floor. At the south end of the hall the ceiling follows the slope of the stair carriage and measures 8' 2¼"

PAVILION V



Room 104 Front stair hall

above the floor below the southwest stair landing.

Walls: The north, east, and south walls are original plaster on brick masonry. The west wall is original plaster on wood lath. The north wall was modified when the archway was installed, perhaps circa 1903.

Baseboard: Between the arched opening in the north wall and door 1031 the baseboard is Type B-2. The remainder of the trim is original 9/16" high baseboard, including a 6" splashboard with a 3/4" molded top (Type B-1).

Chair Rail: Original 3/4" high molded wood rail (Type T-40).

Doors: One original door opening in west wall with two-fascia architrave surround (Type T-22) and one original door opening beneath the stairs with a 3" wide plain fascia surround. The archway in the north wall replaces an original door opening in the same position. The original door and doorway matched existing door 1031.

No. 1041: Original 1 1/2" thick stile-and-rail door with six raised panels (Type D-19). Hardware: Original pair of 4" iron butt hinges and a circa 1929 5/16"

high brass or bronze mortise lock stamped "P 10." Each side has a brass or bronze 7" escutcheon plate and 2 1/4" diameter knob. There is evidence on the west face for the position of an original 4" by 6" box lock.

Windows: Two original windows in the east wall with splayed, plain reveals and 6 1/2"-wide two-fascia surrounds (Type T-23) terminating on splashboard-height plinths. Each window has original 6/6/6 triple rope-hung sash with 12" by 18" panes, 3/16" muntins, and a recent thumb latch on each of the meeting rails. The southeast window extends beneath the stairway and lights the basement stair.

Staircase: Original open-string stair with a continuous run of eleven risers to a triangular landing, three risers to a second triangular landing, and six risers to arrive at the second floor stair hall. The treads of the first and last runs are angled, with the first run treads angling from the southeast to the northwest and the last run treads angling from the southwest to the northeast. The stained, varnished, bullnosed treads range from 10 1/4" deep at the interior edge to 11 1/4" deep along the exterior edge. The risers are approximately 8 1/4" high (including a 1" nosing) and are trimmed with a small cavetto molding beneath the nosing. The string brackets are stylized c-scrolls.

The 2" diameter handrail is supported by rectangular 3/8" by 3/8" balusters, spaced approximately 4 1/2" apart (two per tread). The rail is painted dark brown, and the balusters are painted white. A baluster with similar detailing extends across the southeast window. A 2' 3"-wide carpet runner extends the full length of the stairs. The wall surfaces located below the stringers enclose the basement stairway; the original wooden surfaces are divided into rectangular and triangular raised panels.

Heating: One three-column, fourteen-section, cast-iron, hot-water radiator is located against the west wall. The radiator is marked "American Radiator" and "Peerless."

Lighting: There is no artificial lighting in the hall. Electrical wiring from a wall fixture remains in the west wall south of door 1031. One duplex receptacle in baseboard on east wall.

Paint Investigation: Evidence for the original finishes was found on the various surfaces in the hall. The wood trim was first covered in a yellowish white (2.59/2) paint. The stair balusters were covered in the same yellowish white, but the handrail was simply varnished wood. The treads and risers were finished in a moderate brown (5YR4/4). A reddish brown (10R3/2) was applied to the top surface

ARCHITECTURAL DESCRIPTION

of the chair rail and the vertical face of the baseboard. The plaster walls were first painted in a pale pink (2.5YR9/2) color, followed by a pale yellow (2.5Y9/4). The doors were grained to imitate mahogany.

ROOM 105 VESTIBULE

This gallery-like space serves as the connector (hyphen) between the original pavilion constructed in 1819-23 and the large rear addition of circa 1850. This connector is contemporary with the rear addition, although the second-story space above this room was increased in height circa 1903/1929.

Originally, the north and south doorways both opened directly to the exterior, probably onto porches and stairs descending to the yard. In circa 1903/1929 the connector was enlarged to the south, causing the south entry to open into an enclosed stairway.

The space primarily served as a connecting passage until circa 1903 when the pavilion was no longer occupied by a single family. Circa 1903, this space became the entry vestibule for the rear portion of the pavilion, which was then occupied by Professor Kent.

The space has continued to serve as the primary entry vestibule for the rear portion of the pavilion.

Floor: Original random-width (4½" to 5¾") tongue-and-groove boards, running east-west.

Ceiling: Painted plaster on twentieth-century expanded metal lath, which has been applied over the original split lath, 9' 0" above the floor.

Walls: Original plaster on brick masonry. The east masonry wall is the original rear (west) exterior wall of the 1819-23 pavilion.

Baseboard: Original 5½"-high splashboard with flush bead along top edge (Type B-4).

Doors: One original doorway in north wall and one door opening directly opposite in the south wall, with two-fascia architrave surrounds (Type T-26). These openings are contemporary with the circa 1850 construction of the connector and rear addition.

The opening with transom in the east wall is the original (1819-23) rear entry to the pavilion. It became an internal doorway when the rear addition was constructed circa 1850. The opening in the west wall dates to circa 1850 and never included a door.

No. 1051: Original circa 1850 1½" thick stile-and-rail door with four recessed panels (Type D-16). Hardware: Pair of original 3" butt hinges and later

¾" by 6½" iron box lock with brass knobs and oval escutcheon with cover plate. A 2½" by 3½" iron "Corbin" deadbolt with brass knob is surface-mounted to the south face above the box lock. A twentieth-century 2¼" by 6½" brass or bronze mail slot has been inserted in the lock rail. Physical evidence on the lock rails reveals that the door originally (circa 1850) had a 4½" by 6¾" box lock and keeper on the south face and a 2"-high oval keyhole escutcheon on the north face.

No. 1052: Original circa 1850 1½" thick stile-and-rail door with four recessed panels (Type D-16). Hardware: Pair of original 3" butt hinges and a later ¾" by 3¾" iron box lock with brass knobs and small escutcheon. A twentieth-century 2" by 3" iron "Corbin" deadbolt with brass knob is surface-mounted to the north face above the box lock. Physical evidence for the same type of original hardware found on door 1051 was found here.

Windows: One original window opening in north wall framed with 6" two-fascia architrave (Type T-26) terminating on 2" thick sill. The original 6/6 double rope-hung wood sash have 12" by 16" panes, ⅙" muntins, and a twentieth-century sweep thumb latch on the meeting rails. There was never a window opening in the south wall.

Heating: A three-column, twenty-section, ornamental cast-iron radiator is located beneath window. There are no manufacturer's marks on the radiator.

Lighting: There are no lighting fixtures in this room. Electrical features include a switch plate with three switches west of door 1051 and duplex receptacles in the north and east baseboards and in the south wall.

Plumbing: A twentieth-century 8" by 2' 6" pipe chase, approximately centered on the south wall, has recently been removed, revealing plumbing risers that serviced the second floor bathrooms (Rooms 206, 207, and 210).

Other Features: The electric bell for a twentieth-century doorbell is mounted to the north wall, immediately west of door 1051.

Paint Investigation: The white plaster wall surfaces retain paste residue, which indicates that wallpaper was the first finish here. There are only two recent painted finishes on the plaster. The woodwork was first finished in a yellowish white (2.5Y9/2). The baseboard was covered in a grey (10YR6/1) finish. Two successive layers of graining cover the doors; the first may imitate oak, and the second is a mahogany finish. A very dirty soot-like layer covers the second paint layer in this room.

PAVILION V

ROOM 106A BREAKFAST ROOM

The three large, south-facing windows provide an abundance of natural light and indicate that this room may have been used as a conservatory with access from the dining room. A circa 1920 aerial view of the pavilion clearly shows this addition; if the photograph is correctly dated, this room and the adjoining space (106) may have been constructed circa 1903 when the pavilion was modified for the joint occupancy of Professors Smith and Kent. At that time, the kitchen was probably still in the basement (Room B05). If in fact the photograph is of a later date, then the construction may have occurred in 1929.

At some later date the large opening in the north wall was created and the swinging door was installed in the east opening. Unfortunately, no documentation has been found to confirm the dates for any of this work.

Floor: Circa 1903 2½" subfloor boards, running east/west. At the west end of the room, the floor steps up to a platform raised 10½" above the floor. The platform is surfaced with ¾"-wide tongue-and-groove boards. This platform was constructed when the doorway was created in the west wall sometime after the creation of the room. The floor appears to have been covered with vinyl (removed in 1992).

Ceiling: Painted plaster, 12' 3" above floor.

Walls: The walls are plaster on brick masonry and primarily date to circa 1903/1929, except for the east wall, which was part of the brickwork of the 1819-23 pavilion, and the north half of the west wall, which dates to the construction of the rear addition circa 1850. Until 1992 there were two plaster-on-lath partition walls enclosing a small closet in the northwest corner of the room.

Baseboard: 5½"-high splashboard with molded top (Type B-4), dating to circa 1903/1929 or later.

Doors: One door in the west wall leading to exterior stairs, framed with a single-fascia architrave surround (Type T-34). This door opening was probably created circa 1929 or later from what was a window opening. The opening did not extend to the floor, making the inserted floor platform necessary.

A swinging door has been inserted in an original 1819-23 window opening in the east wall. A wood infill panel with four raised panels had been installed above the door. The opening has a two-fascia architrave surround (Type T-2). The door dates to circa 1929 or later.

Until 1992 there was a doorway opening into the

former closet in the northwest corner of the room. The opening was framed with a 3"-wide single-fascia architrave with a plain, beveled perimeter molding.

No. 106A1: A circa 1929 (or later) 1¼" thick stile-and-rail door, with 15 lights above a raised panel (Type D-14). The panes are 6" by 9" and the muntins are ¾" wide. Above the door there is a six-light fanlight. Hardware: Pair of 2¾" butt hinges and a 5½" bronze mortise lock stamped "P 12." Each side has a bronze 7" escutcheon plate and 2¼" diameter knob. A 3½" bronze "Corbin" deadbolt with a cast-iron casing is surface mounted to the east face.

On the exterior side of the opening there is a 1" thick stile-and-rail door with two screened panels. Hardware: Pair of 2¾" iron/steel spring hinges and a bronze mortise latch. A 3" steel slide bolt is surface mounted to the east face; physical evidence indicates the bolt has been moved down approximately 1".

No. 106A2: This 1½" stile-and-rail door with two recessed panels was removed in 1992.

Windows: Three circa 1903/1929 arched windows in south wall, framed with 5"-wide single-fascia architraves with 2"-wide beveled perimeter moldings. The architraves terminate on a continuous 1¼" thick bullnosed sill and 3½"-high apron. Each window features 25/25 double rope-hung sash below a fixed, nine-light fanlight. The panes of the 25/25 sash are 6" by 8", and the muntins are ⅝" wide. There is a sweep thumb latch on each of the meeting rails.

Heating: Five column, 40-section cast-iron, hot-water radiator beneath windows.

Lighting: There is currently no artificial lighting in the room; a ceiling fixture was removed in 1992. Electrical elements include switches on the east and west walls, a duplex outlet in the south wall, and a grounded duplex outlet surface mounted to the south wall with rigid conduit running down to the basement.

Plumbing: Capped-off domestic waste and supply lines remain in the north wall, to the west of the opening into Room 106. Until 1992 these lines were covered by a horizontal wood fascia.

Other Features: There is a set of five steps in the northwest corner of the room, rising from south to north. The steps are approximately 5' 3" wide, with 8½" treads (including a ½" nosing) and 7" risers (including a ¾" nosing). The east face of the stairs is enclosed with a vertical, beaded-board partition. Until 1992 the west half of the steps was enclosed within a closet, and the east half of the steps was cov-

ARCHITECTURAL DESCRIPTION

ered by casework. As originally constructed circa 1903/1929 the "steps" were fully exposed with a semi-circular window in the wall above the steps. This arrangement was constructed to cover the stairwell below and to provide light to the stairway in Room 105A. The short flight of "steps" served as shelving. The platform was constructed when the west exterior door was created from what was formerly a window.

Paint Investigation: The circa 1903/1929 wood trim was first finished in a yellowish white (2.5Y9/2) paint followed by at least 12 more finishes. The eighth finish, a light grey, is the first finish on the trim of the wide opening in the north wall.

ROOM 107 REAR STAIR HALL

The stair hall serves as the point around which all of the rooms in the rear addition are arranged. Prior to the twentieth century, the stairway did not continue to the basement. The small horizontal window opening, which now provides natural light to the hall and to the stairway, was inserted in the twentieth century, probably circa 1903/1929. Evidence for an earlier window condition has not been found.

The circa 1850 staircase was obviously modeled on the original (1819-23) stair in the front of the pavilion.

Floor: The original, circa 1850 flooring survives.

Ceiling: Original, circa 1850 painted plaster, 9' 11½" above floor.

Walls: The east, west, and south walls are original plaster on brick masonry. The north wall is plaster on wood lath.

Baseboard: Original 5¼" splashboard with a flush bead along the top edge (Type B-4).

Doors: One original doorway in north wall, two original doorways in west wall, and a twentieth-century doorway in the south wall, each with a two-fascia architrave (Type T-26). The opening in the east wall is also original. It never included a door.

No. 1071: A twentieth-century 1⅜" thick stile-and-rail door with four recessed panels (Type D-17). Hardware: Pair of 3" butt hinges and a 3¼" by 3¼" iron box lock with brass knobs. The south face of the door has a small metal keyhole escutcheon. The door opening was created circa 1903 or 1929 in what was originally a solid partition.

Windows: The rectangular, pivoting window in the south wall at the level of the stair landing provides some natural light for the hall.

Staircase: Open-string stair with a straight run of

11 risers to arrive at the south landing and a straight run of six risers returning north to arrive at the second floor stair hall (Room 209). The treads are 3' 2" wide by 10¾" deep, including a 1" nosing, and the risers are 7½" high, including a 1" nosing. A small (⅝") cavetto molding has been applied beneath each tread. The stairs have stylized c-scroll string brackets. The 2¼" diameter handrail is supported by 7⁄8" by 1⅛" balusters spaced 4½" to 5" apart (two per tread). The wall surface below the stringer is plaster on lath. This stair is original to the rear addition and dates to circa 1850. It is similar in detail to the stair in the original (1819-23) portion of the pavilion.

Lighting: There are no lighting fixtures in the hall. Other electrical features include a junction box for a wall sconce between doors 1091 and 1101 and switches on the north and east walls.

Paint Investigation: The original finishes found in the hall date to circa 1850. The trim, including stair newels and balusters, was first finished in a yellowish white (2.5Y9/2) paint. The simple baseboard and the stair risers were painted gray (10YR6/1). The handrail was varnished, and traces of varnish were found on the treads. The plaster walls were covered with wallpaper; tiny fragments showed a pink-and-gray ground with a gray-and-white imprint.

ROOM 107A LANDING

Originally this small space was an under-stair closet with access from Room 110 through a doorway in the west wall. That door is still in place, but the opening has been covered over in Room 110. It was probably about 1903, when the rear addition was converted into a separate residence, that the stairway to the basement was created. At some later date, perhaps circa 1929, the doorway opening to the stair hall (107) was created.

Floor: Original 4½" to 5½" wide floorboards, running north/south. The floorboards appear to be continuous from Room 107. The floor directly under the lower run of the stair was cut out when the basement stairway was installed.

Ceiling: Plaster on lath, 6' 4" above floor. This is the original circa 1850 surface.

Walls: The north wall is paneled with vertical, beaded boards. The south and east walls are original plaster on masonry. North of door 107A2 the west wall is covered with vertical, beaded boards on masonry, while south of the door the wall is plaster on masonry.

PAVILION V



Room 107 Rear stair hall



Room 108 Kitchen

Baseboard: Original 5½" splashboard with flush bead along top edge (Type B-4) on east and south walls and on the west wall south of Door 107A2.

Doors: Two later door openings in the north wall and one original door opening in the west wall. The northeast opening has a plain fascia surround at the top and on the east side. The original west door is set flush with the wall and is no longer operable. The opening has a plain fascia with a flush bead at the south end of the door.

No. 107A1: A circa 1903 1½" thick stile-and-rail door with four raised panels (Type D-18). Hardware: Pair of 3½" butt hinges and a 5½" bronze mortise lock with brown mineral knobs. The knobs are older than the lock. There is a 2½" by 7½" metal escutcheon plate on the south face of the door, and a wood cleat with a 3" steel slide bolt is mounted to the north face of the door.

No. 107A2: An original circa 1850 stile-and-rail door with four recessed panels (Type D-28). Hardware: All of the original and later fittings are missing. There is evidence on the north end of the lock rail for the original Carpenter-type box lock. There

is evidence on the south end of the lock rail for a later 3½"-high Victorian box lock.

Lighting: Electrical elements include a porcelain light socket mounted to the ceiling, a switch in the north wall, and rigid conduit running through the west wall.

Other Features: A 1' 7½"-deep shelf on the south wall is supported by wood cleats on the east and west walls.

ROOM 108 KITCHEN

This small room may have served as a kitchen as early as circa 1929, when the rear portion of the pavilion was occupied by Professor Sparrow, but the earlier and original function for this room remains unknown. When the adjoining larger rooms functioned as bedchambers in the nineteenth century, this room may have been a bathing room, a dressing room, or a small bedroom. Evidence in the floor framing indicates that a stairway to the basement may have been located here.

Most evidence for earlier uses was destroyed

ARCHITECTURAL DESCRIPTION

when the most recent kitchen fittings were installed.

The door was originally hinged so that it opened toward the east wall rather than against the west wall, as it currently does.

Floor: 3"-wide pine flooring, running north-south. This flooring was installed in the twentieth century. The framing of this floor can be seen in the basement. Two joists, inserted after the other framing, may be in the position of an original stair opening.

Ceiling: Original plaster, painted, 9' 11" above floor.

Walls: The north, east, and west walls are circa 1850 plaster on brick masonry. The south wall is circa 1850 plaster on lath. The wall within the cabinet on the north wall is covered with recent plaster on expanded metal lath.

Baseboard: A 5½"-high splashboard with a bead at the top edge has been removed from the south, east, and west walls.

Doors: One original doorway in south wall with a two-fascia architrave surround (Type T-26).

No. 1081: An original circa 1850 1¼" thick stile-and-rail door with four recessed panels (Type D-30). Hardware: Pair of 3" butt hinges and a ¾" by ¾" iron box lock with pair of brass or bronze knobs. The door was originally hinged to the opposite jamb, and the molded panels faced south. Originally a 4" by 4¾" box lock was mounted on the plain, north face (Room 108 side) of the door.

Windows: One original window opening in the north wall, framed with a 6"-wide two-fascia architrave (Type T-26). The architrave has been cut off at the height of the twentieth-century counter splash-guard, approximately 3' 5½" above the floor. The window extends down another 6" to a sill that has also been cut off. The original 6/6 double rope-hung wood sash have 12" by 16" panes, ⅝" muntins, and a bronze sweep thumb latch on the meeting rails.

Lighting: Fluorescent lighting fixture surface mounted to ceiling. Other electrical elements include a switch east of Door 1081, three duplex receptacles in the east and west walls, and an electrical receptacle for a range.

Plumbing: Double basin, enameled, cast-iron sink marked "Kohler USA, 5950, 42x21-2S, 7 16 56." Copper cold-water line in east wall to service ice-maker.

Other Features: There are 2' 1½"-deep cabinets on the north and east walls and a similar 1' 0"-deep cabinet on the west wall. The cabinets are finished with pink plastic-laminate counter tops, and the plain

wood doors have chrome pulls and small 2½" butt hinges. Along the east wall a 1' 0" deep by 5' 5" high upper cabinet is mounted flush with the ceiling. Beneath this cabinet a "Rangaire" stove hood remains in place. All of these fittings were installed in the mid-twentieth century or later.

ROOM 109 DINING ROOM

The intent of the circa 1850 construction of the rear addition was to provide more living space for Professor Harrison's large family. This ample room probably served as a bedchamber at that time. Originally, there was no connection between this room and Room 110. The existing door and the doorway between Rooms 109 and 110 may have been removed from the partition separating Rooms 211 and 212 and installed on the first floor, circa 1903. When the rear porch was constructed, circa 1929, the French doors were installed in the original west window opening.

The room probably functioned as a dining room for Professors Kent, Sparrow, and Abernathy as well as for Professor Redmond.

Floor: Original random-width, tongue-and-groove boards, running east-west.

Ceiling: Original plaster, painted, 9' 9" above floor.

Walls: Original plaster on brick masonry.

Baseboard: Original 5¾"-high splashboard, with a flush bead along the top edge and a flattened shoe molding along the bottom edge (Type B-4).

Doors: Three door openings with two-fascia architrave surrounds (Type T-26). The doorway in the east wall is an original circa 1850 opening. The west door opening dates to circa 1929 and was created in what was an original window opening. The south door opening has a paneled reveal. This doorway was installed here in the later nineteenth century, or perhaps circa 1903. The architrave may have been removed from an original position in the partition separating Rooms 211 and 212.

No. 1091: Missing. The door here would match the door in place in opening No. 1081 (Type D-30).

No. 1092: A circa 1850 1¼" thick stile-and-rail door with four recessed panels (Type D-20). This door may have been a former opening between Rooms 211 and 212. Hardware: Recent pair of 3½" butt hinges and ¾" by 4½" iron box lock with brass or bronze knobs and keyhole escutcheon. The door was originally hinged on the opposite stile with 3" hinges, and there is evidence on the lock rail for an

PAVILION V

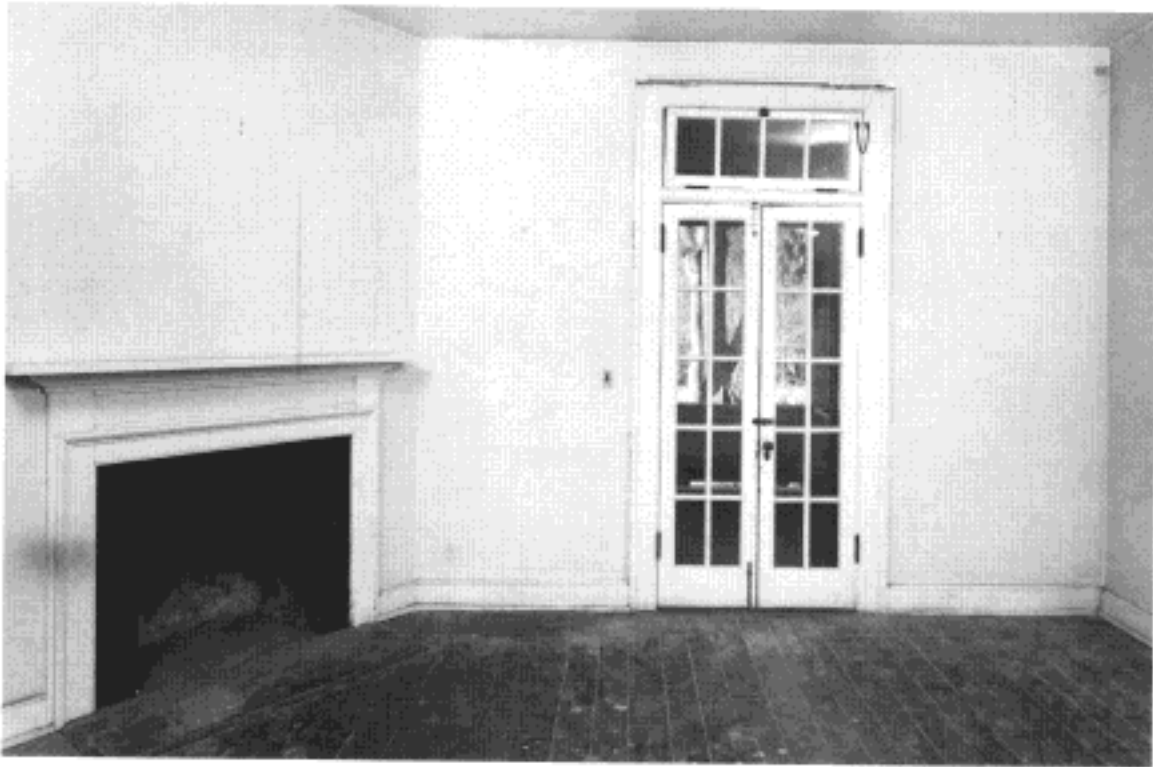

Room 109 Dining room

original 4" by 4½" box lock (possibly a Carpenter-type lock).

No. 1093: Circa 1929 pair of 1¾" thick stile-and-rail glazed doors (Type D-24). Each door has ten lights, with 7" by 14" panes and 1½" muntins. A four-light rectangular transom above the doors has 8½" by 12" panes and 1½" muntins. Hardware: Pair of 4½" brass or bronze butt hinges with ball tips at each door. The north leaf has a 5" mortise lock with brass or bronze knob and escutcheon on interior face and a brass or bronze latch and escutcheon on west face. South leaf has 3¾" mortised keeper, 3" slide bolt on lock stile, and 9½"-high brass or bronze slide bolts surface mounted to top and bottom rails (these are replacements; evidence on the door indicates that 9" bolts, similar to those on Door 1102, were originally used). Transom sash has pair of 3½" butt hinges at bottom rail, a 1½" latch at top rail, and a chain at the north stile.

A pair of 1" thick stile-and-rail screened doors has been installed at the west edge of the door opening. Hardware: Pair of 2½" butt hinges on each leaf,

a "Weiser" brass or bronze mortise latch in north leaf, and a keeper mortised into south leaf.

Window: One original circa 1850 window opening in the north wall, framed with a 6"-wide two-fascia architrave (Type T-26) terminating on a 1" thick sill above a ¾" cavetto molding. The stop beads are missing. The sash cords for the original 6/6 double rope-hung window sash are missing. The sash have 12" by 16" panes, ¾" muntins, and a sweep thumb latch on the meeting rails.

Fireplace: The original masonry chimney breast extends diagonally across the southwest corner of the room, approximately 6' 0" wide. The firebox is built of 2½" by 8" bricks, painted black. A plaster surround is bordered by a 6"-wide fascia with a 2" ogee perimeter molding. Above the surround is a 5½" frieze with a plain, recessed panel. The cornice is 4½" high. A brick hearth, made of 3½" by 7¼" bricks, is painted black. Stylistically, the mantel appears to date to the early nineteenth century rather than circa 1850, and it is very different in character from the mantels on the second floor; it is more

ARCHITECTURAL DESCRIPTION

likely that it is a circa 1903 revival of the early mantel form. However, the paint layering on the mantel suggests that it dates to circa 1850, further confusing the mantel assessment.

Heating: A three-column, ten-section ornamental, cast-iron hot-water radiator sits below the window. There are no manufacturer's marks on the radiator.

Lighting: There are no lighting fixtures in the room. Wiring from the fixtures removed in 1992 remains in the ceiling and in the south wall, and two metal plates on the east wall cover junction boxes for fixtures removed in 1992. Other electrical elements include a switch and dimmer control north of door 1091, a switch on the west wall, a switch plate on the south wall, two duplex receptacles in the east wall, and one duplex receptacle in the north baseboard.

Paint Investigation: The interpretation of the paint layering in this room is complicated by the various modifications that have been made, beginning circa 1903. The circa 1850 woodwork was first finished in a yellowish white (2.5Y9/2) paint very much like the original and subsequent yellowish white used in the original 1819-23 portion of the pavilion. The baseboard was covered with a gray (10YR6/1) color, and the original door was grained to imitate what may be oak. The earliest finish on the mantel is a glossy black, and it probably dates to circa 1850. The door trim on the south wall is covered in layers of yellowish whites, and the paneled door retains evidence for oak graining. The trim of the glazed doors in the west wall includes three finish layers; the first is a yellowish white.

The plaster walls were first finished with wallpaper, followed by a pale gray (5YR8/1) paint.

ROOM 110 PARLOR

Upon the completion of this room circa 1850, it served as a bed chamber. At the south end of the east wall, a doorway provided access to a closet located beneath the hall stairway.

After the circa 1903 renovations and the occupancy by Professor Kent, the room may have been used as a parlor, with the adjoining and newly connected space (Room 109) functioning as a dining room. It is also possible that these uses were reversed.

The exterior French doors were installed in the original west window opening when the rear porch was constructed, circa 1929.

Floor: Original random-width, tongue-and-groove

boards, running east-west.

Walls: Original plaster on brick masonry. A closet door opening at the south end of the east wall was covered over circa 1929.

Ceiling: Original plaster, painted 9' 9" above floor.

Baseboard: Original 5½"-high splashboard with a flush bead at the upper edge (Type B-4). A break in the east baseboard, 4' 1½" from the south wall, relates to the original door opening in that wall.

Doors: Three doorways with two-fascia architrave surrounds. The north door opening has a paneled reveal and may have been inserted in the wall circa 1903. The doorway in the west wall was created circa 1929 in what was an original window opening.

No. 1101: Door is missing. The door was probably removed in the twentieth century when the room became a parlor. The jamb retains an iron-and-brass keeper, 4⅛" high, for a Carpenter-type box lock.

No. 1102: Pair of circa 1929 1¾" thick stile-and-rail glazed doors (Type D-24). Each door has ten lights, with 7" by 14" panes and 1⅛" muntins. A four-light rectangular transom above the doors has 8½" by 12" panes and 1⅛" muntins. Hardware: Pair of 4½" brass or bronze butt hinges, with ball tips, at each door. The north leaf has a 5" mortise lock with bronze knob and escutcheon on the east face and a brass or bronze latch and escutcheon on the west face. South leaf has 3¾" mortised keeper and 9"-high brass or bronze slide bolts surface mounted to top and bottom rails. Transom sash has pair of 3½" butt hinges at bottom rail, a 1½" latch at top rail, and a chain at the north stile.

A 1" thick stile-and-rail screened door has been installed at the west edge of the door opening. Hardware: Pair of 3" spring hinges, a 4" pull, and a hook-and-eye catch.

Windows: Two original circa 1850 window openings in the south wall, framed with 6"-wide two-fascia architrave terminating on 1¾" thick sills. The original window sash are 6/6 double rope-hung sash; they have 12" by 16" panes, ⅝" muntins, and brass sweep thumb latches on the meeting rails. A third original window opening in the west wall was converted into a doorway circa 1929.

Fireplace: The original masonry chimney breast extends diagonally across the northwest corner of the room, approximately 6' 0" wide. The firebox is built of 3½" by 7¾" bricks painted black. A plaster surround, painted black, is bordered by a 6" fascia with a 2" ogee molding. Above the surround is a 5¾"

PAVILION V

frieze with a plain, recessed panel. The cornice is 4¼" high. A brick hearth, made of 3½" by 7¾" bricks, is painted black. Paint layering indicates that the wooden mantel may date to circa 1850, although stylistically it appears older. It is likely that the mantel is a circa 1903 revival of the early mantel form. Nail types used in the construction of the mantel need to be analyzed to determine the period of this fitting, as well as that of the mantel in Room 109.

Heating: A three-column, ten-section cast-iron hot-water radiator is located below the southeast window. There are no manufacturer's marks on the radiator.

Lighting: Electrical elements include a switch south of door 1101 and four duplex receptacles in the baseboard.

Paint Investigation: The changes made to the room circa 1903 and 1929 became apparent from the paint layering on the various surfaces. The original wood trim was first finished with a yellowish white (2.5Y9/2) used at various times throughout the pavilion. The baseboard was painted gray (10YR6/1) and the northeast door (now missing) may have been grained to imitate oak. The layering on the mantel includes a brown (5YR5/2) paint, then a glossy black, followed by a layer of graining and three layers of white.

Wallpaper was used as the first finish on the plaster walls, followed by layers of various white paints. There were probably several wallpapers used here; the wallpaper may have been painted over and removed prior to the application of the most recent paints.

ARCHITECTURAL DESCRIPTION

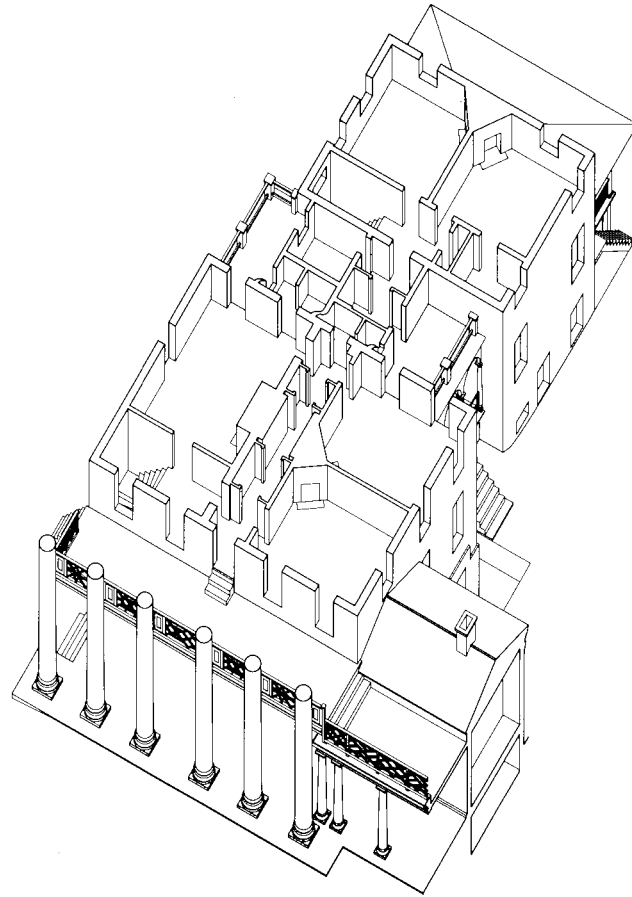

SECOND FLOOR

The second floor of the original pavilion retains most of its original character. The plan as it exists duplicates the original Jefferson floor plan. The only exceptions are the brick chimney masses in each room, where stoves were shown on the original plan. As constructed, fireplace masses were placed in each room; cast-iron Franklin stoves may have been installed in the fireplace openings.

In plan, the second floor includes a central hall, which extends from the front to the rear of the pavilion. The most distinctive feature in the hall is the tall, arched masonry opening through the central chimney mass. North of the passage are two bedchambers, each with a corner fireplace. Originally these rooms were joined by a doorway in the partition that separates them. South of the passage there is the

PAVILION V

stair hall and the large formally detailed room that functioned as the professor's parlor. As in all the pavilions, the latter room features a finely detailed entablature.

The expansion of the pavilion circa 1850 resulted in the addition of two large bedchambers, a dressing room, and a stair hall at the west end of the second floor. Later, a bathroom and closet were built in the dressing area. These were joined to the original pavilion by a connecting corridor that had a very low ceiling and a large opening in the south wall.

Additional modifications were made in the early twentieth century, probably circa 1903/1929, when the connector was enlarged. This work included the raising of the roof to a higher level and the addition of two rooms on the south side of the connector; one of these rooms was fitted as a bathroom, either then or later.

Two bathrooms were installed in the original portion of the connector during the twentieth century.

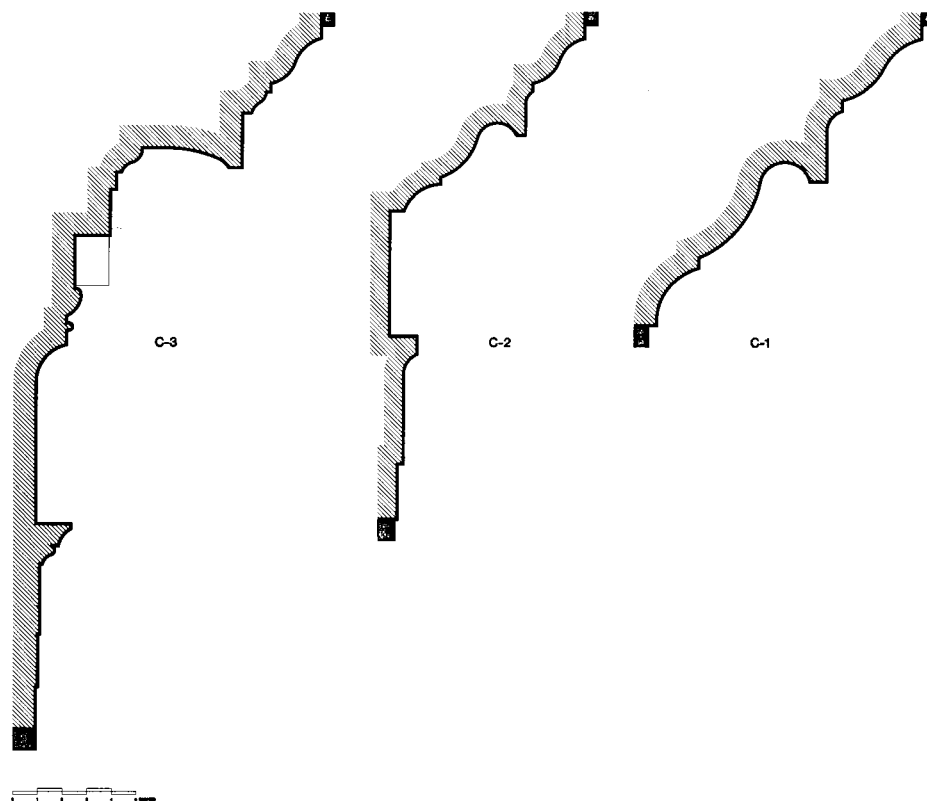

Room cornice profiles

ARCHITECTURAL DESCRIPTION

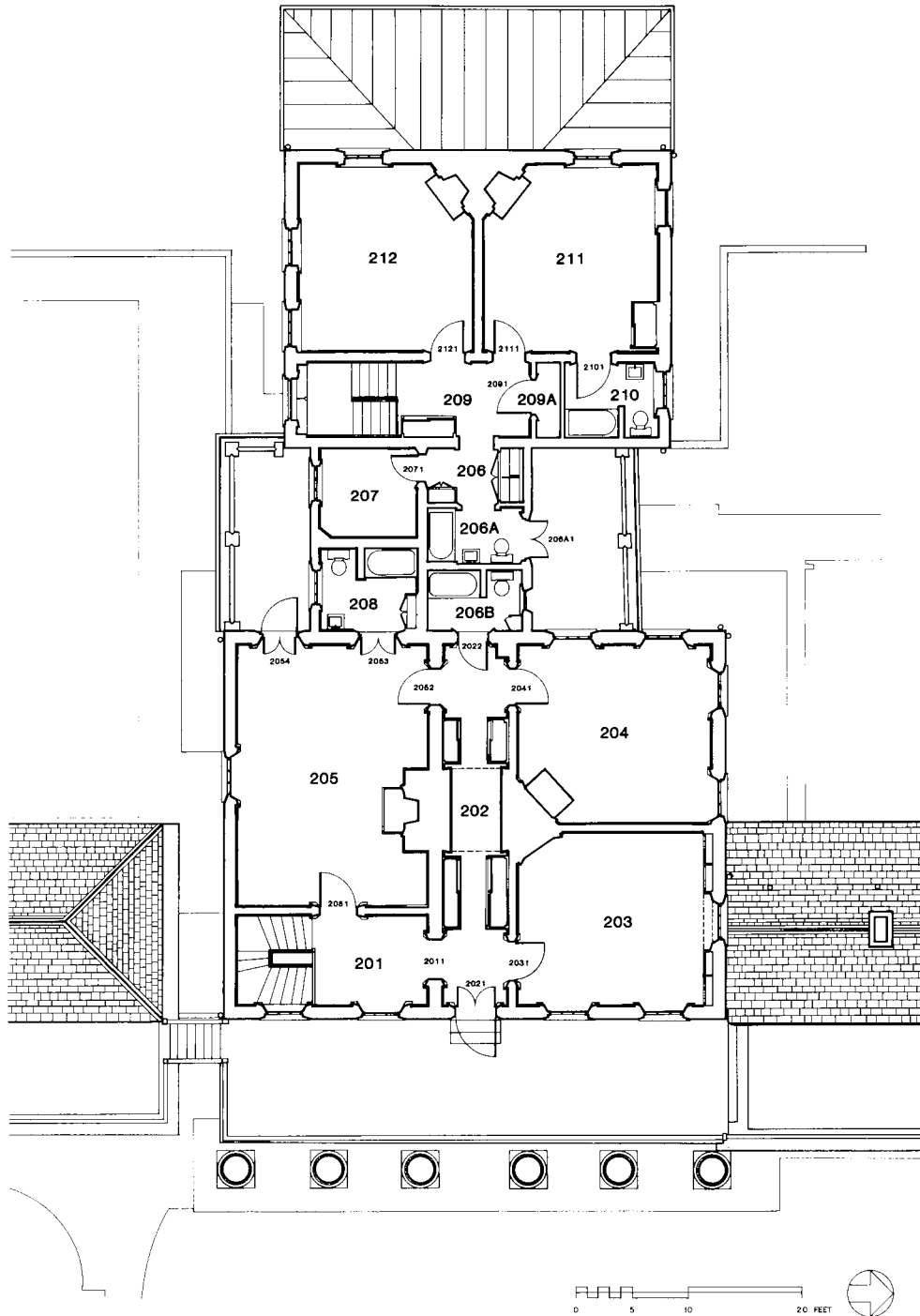

Second floor plan

PAVILION V



Room 201 Front stair hall

ROOM 201 FRONT STAIR HALL

The stair hall has always been part of the professor's private domain. The stairway ascends from the first floor and doorways open from the hall to the original parlor (205) and to the central corridor (202). Four windows provide natural light to the stairway as it ascends from the first floor to the second floor. The plan of the hall follows that delineated by Jefferson; the only difference is in the configuration of the stair treads. Jefferson drew the treads perpendicular to the stair stringers, with winders at the south wall to return the stair carriage. As built, the treads were skewed.

Floor: Original random-width, tongue-and-groove boards, running north-south, stained and varnished.

Ceiling: Original plaster on lath, painted, approximately 10' 8" above the floor.

Walls: The south, east, and north walls are original plaster on brick masonry. The west wall is original plaster on wood lath.

Baseboard: Original 8 $\frac{1}{2}$ "-high baseboard, includ-



Room 202 Hall

ing a 6" splashboard and a 2 $\frac{1}{4}$ " molded top (Type B-2).

Cornice: Original 2' 3"-high wood entablature, composed of a three-fascia architrave, a plain coved frieze, and a denticulated cornice (Type C-1).

Doors: Two original door openings, one in the north wall and one in the west wall, with two-fascia architraves (Type T-35). The reveal of the north opening is faced with recessed paneling; the door has been removed.

No. 2011: Door is missing. The six panel door that was slightly cut down at the sides and placed in the first-floor doorway No. 101B1 was probably located here.

Windows: Two original window openings in the east wall with splayed paneled reveals and paneled heads are framed with 6 $\frac{1}{2}$ "-wide two-fascia architraves terminating at splashboard-height plinths (Type T-36). The reveals are divided at the level of the meeting rails, and each portion has a tall, thin rectangular panel with a small square panel above. Each opening has original 6/6 double rope-hung sash, with 12" by 18" panes and $\frac{3}{8}$ " muntins. Hard-

ARCHITECTURAL DESCRIPTION

ware includes recent sweep thumb latches on the meeting rails.

Staircase: The original stair from the first floor is terminated in the southwest corner of the room. The baluster railing continues across the stair opening to the east wall, where it is supported by a turned newel post.

Heating: The only heat for the space is supplied by the single radiator in the first floor stair hall (Room 104).

Lighting: There is no artificial lighting. Wiring in the wall west of the stairwell and a junction box mounted in the ceiling serviced lighting fixtures removed in 1992. Other electrical elements include a pair of switches with plastic switchplates flanking door 2051 and two duplex receptacles in the baseboard.

Paint Investigation: The finish evidence found here follows that uncovered in the first floor stair hall (104). All of the wood trim, including the massive entablature and the stair balusters, was originally covered with a yellowish white (2.5Y9/2) paint. The vertical face of the baseboard was painted with a reddish-brown (10R3/2) paint, and the doors were grained to imitate mahogany.

Traces of original and early finishes found on the plaster wall surfaces include a pale pink (2.5YR9/2), a pale yellow (2.5Y9/4), and evidence of wallpaper.

ROOM 202 HALL

This tall, narrow hall retains most of its original character. The arched opening that joins the two chimney masses is a dramatic feature. The window at the west end of the hall was removed when the rear addition and connecting hyphen were constructed circa 1850. The loss of natural light may have prompted the insertion of glazed panels in the original paired doors at the east end of the hall.

Floor: Original random-width (4½" to 6"), tongue-and-groove boards, running east-west, stained and varnished.

Ceiling: Original plaster on wood lath, painted, 10' 8" above the floor. An access panel at the west end of the ceiling opens into the attic. This opening was the original access to the "flat" roof of the pavilion that survives in the attic created when the hipped roof was installed in 1837. This opening was modified in 1993 when it was enlarged to accommodate the installation of HVAC equipment in the attic.

Walls: The south, east, and west walls are original plaster on brick masonry. The north wall is original plaster on split-wood lath. The chimney masses from the fireplaces in Room 205 to the south and Rooms 203 and 204 to the north project into the hall and are joined by a 7' 1"-wide plastered masonry arch. The arch is trimmed with 6½"-wide architraves terminating at bull's-eye corner blocks at the arch imposts. The profile of the trim and the corner blocks is the same.

Baseboard: Original 8¼"-high baseboard, including a 6" splashboard and a 2¼" molded top (Type B-2).

Cornice: Small, 2" wood molding. This is a later insertion.

Doors: Five original door openings, two in the north wall, one in the east wall, and two in the south wall, with 6¼"-wide two-fascia architraves (Type T-35). The reveals of the south openings are faced with recessed paneling. The door in the southwest opening has been removed. A sixth door opening, in the west wall, was a window prior to circa 1850 and has an architrave with the same profile as the other openings.

No. 2021: Original pair of 1¼" thick stile-and-rail doors. Each leaf has two glazed panels above a raised panel (Type D-21); the glazing is a later insertion. Hardware: Pair of original 5" iron butt hinges at each leaf, and a circa 1929 5¼"-high brass or bronze mortise lock stamped "P 11," with an internal bolt, on the north leaf. The south leaf has a recent 4½" bronze slide bolt on the bottom rail and an original 9¼"-high iron slide bolt on the top rail. A 4"-wide bronze slide bolt secures both leaves. The south leaf originally had a 5"-high mortise lock.

No. 2022: A circa 1850 1½" thick stile-and-rail door with four recessed panels (Type D-26). Hardware: Pair of original 3" butt hinges and a circa 1929 5¼"-high brass or bronze mortise lock stamped "P 10." Each side has a brass or bronze 7" escutcheon plate and 2¼" diameter knob. The door originally had a small (3¼" by 4") box lock mounted on the east face.

Lighting: There is no artificial lighting. Switch with plastic switch plate in north wall, west of door 2031.

Plumbing: A 1' 3" by 8" chase was removed from the northwest corner of the hall in 1992, revealing a copper water line and a galvanized-steel water line.

Other Features: Four 7' 8½"-tall plywood closets, each with two sliding flush doors, placed here after the mid-twentieth century. The two east closets are

PAVILION V

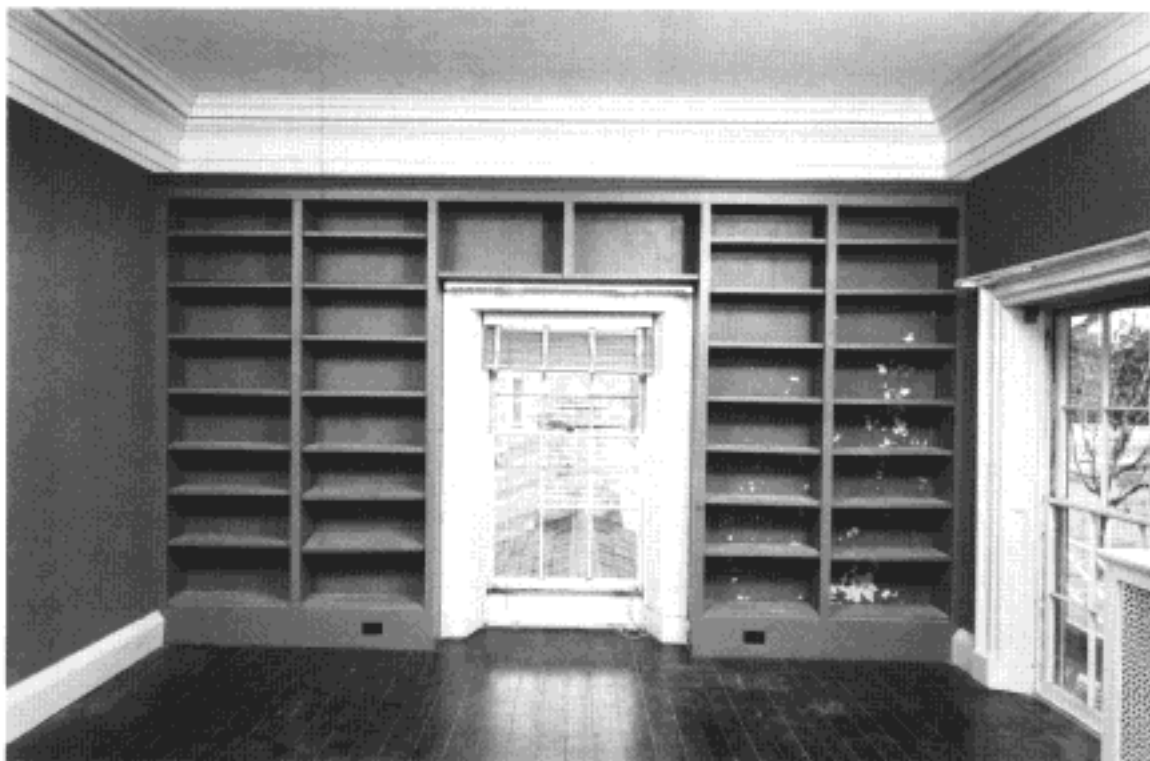

Room 203 Study

1' 7" deep by 6' 0" wide, and the two west closets are 1' 7" deep by 4' 0" wide. A 1½"-high cymatium trims the top of each closet.

Paint Investigation: Originally, the trim was painted yellowish white (2.5Y9/2), and the vertical face of the baseboard was finished with a reddish-brown (10R3/2) color. The doors were grained to imitate mahogany. Evidence on the plaster wall surfaces revealed that a whitewash was used initially; this was followed by wallpaper.

ROOM 203 STUDY

Most recently used as a study, this room was originally a bedchamber, one of two such rooms on the second floor of the original pavilion.

The room includes three windows that extend to the floor, a single door in the south wall, and a corner fireplace. This fireplace may have had a cast-iron Franklin stove.

The Jefferson floor plan illustrates the room much as it is today, except for two differences. There is no

triangular chimney mass in the southwest corner; instead, Jefferson shows a Franklin stove set in the corner. The original floor plan also includes a doorway in the west wall. Breaks in the baseboard indicate that this door may have existed. Pavilion I, which has a plan very similar to this pavilion, has a door that joins the two chambers in the same position.

Floor: Original random-width tongue-and-groove boards, running north-south, stained and varnished.

Ceiling: Original plaster, painted, approximately 10' 8" above the floor.

Walls: The east and north walls are original plaster on brick masonry. The west and south walls are original plaster on wood lath.

Baseboard: Original 8¼"-high baseboard, including a 6"-high splashboard with a 2¼"-high molded top (Type B-2). A break in the north end of the west baseboard indicates the location of a former door.

Cornice: Original 1' 7"-high wood entablature with a two-fascia architrave, a plain frieze, and an unornamented cornice (Type C-2).

ARCHITECTURAL DESCRIPTION



Room 203 Study

Doors: One original doorway in the south wall with a 6½" wide two-fascia architrave (Type T-35).

No. 2031: Original 1½" thick stile-and-rail door with six raised panels (Type D-22). Hardware: Original pair of 5" iron butt hinges and a circa 1929 5¼" high brass or bronze mortise lock stamped "P 10." Each side has a brass or bronze 7" escutcheon plate and 2¼" diameter knob. The door originally had a 5" high mortise lock and 2¼" diameter roses with knobs.

The Jefferson floor plan and physical evidence at the baseboard indicate that originally there may have been a doorway in the west wall. The six-panel door most recently used as the door to Room 101B may be the door from this position.

Windows: Two original windows in the east wall and one original window in the north wall, with splayed, paneled reveals and paneled heads. Each window is framed with a 6½" wide two-fascia architrave (Type T-36) terminating at splashboard-height plinths. The reveals are divided at the level of the meeting rails, and each portion has a tall, thin, rec-

tangular panel with a small, square panel above. Each window has original 6/6 double rope-hung sash, with 12" by 18" panes, ⅜" muntins, and a twentieth-century sweep thumb latch on the meeting rails. The bottom sash of the north window has been raised approximately 9" above the floor to align with the roof ridge above the dormitory rooms immediately north of the pavilion.

Fireplace: The original chimney breast extends diagonally across the southwest corner of the room; it is approximately 4' 9" wide. The surround and firebox opening have been plastered over; the plaster is painted black. The original wood surround consists of a 6½" wide two-fascia architrave. A 1½" thick mantel shelf sits directly above the architrave. This shelf was installed in the twentieth century. The area of the original hearth has been filled in with narrow tongue-and-groove flooring.

Heating: One four-column, 11-section, cast-iron hot-water radiator is located between the two east windows. The radiator is marked "American Radiator" and "Peerless."

PAVILION V



Room 204 Bedroom

Lighting: There is no artificial lighting in the room. A circular metal plate on the south wall marks the location of a previous wall fixture. Other electrical elements include a switch with plastic switch plate east of door 2031, three duplex receptacles in the baseboard, two duplex receptacles in the base of the shelves, and a junction box with a duplex receptacle inside the shelves. Rigid metal conduit runs from the box to a receptacle in Room 204.

Other Features: Twentieth-century, built-in wood bookcases have been installed along the north wall. Each unit includes seven adjustable shelves and a shelf resting on the base (on which electrical outlets are mounted), approximately 9¼" above the floor.

Paint Investigation: The wood trim, including the fireplace surround, was originally covered with yellowish white (2.5Y9/2) paint. The recent mantel shelf is covered with two layers of white paint. The vertical face of the baseboard was painted with a red-brown (10R3/2) color. The paneled door was originally grained to imitate mahogany.

Evidence on the plaster wall surfaces indicates

that wallpaper was the earliest finish, followed by the application of a beige (10YR8/2) paint.

ROOM 204 BEDROOM

This room has maintained its function as one of the two original second floor bedchambers. Natural light enters the room from four windows that extend to the floor. The door in the south wall opens to the central hallway. Evidence indicates that there may have been a doorway in the east wall. The corner fireplace is the most important feature in the room. The fireplace opening may have had a cast-iron Franklin stove.

The current floor plan generally follows the plan drawn by Jefferson; however, the Jefferson plan does not show a triangular chimney mass in the southeast corner, but instead a free-standing Franklin stove is positioned there.

Floor: Original, random-width (3¼" to 5½") tongue-and-groove boards, running north-south, stained and varnished.

ARCHITECTURAL DESCRIPTION

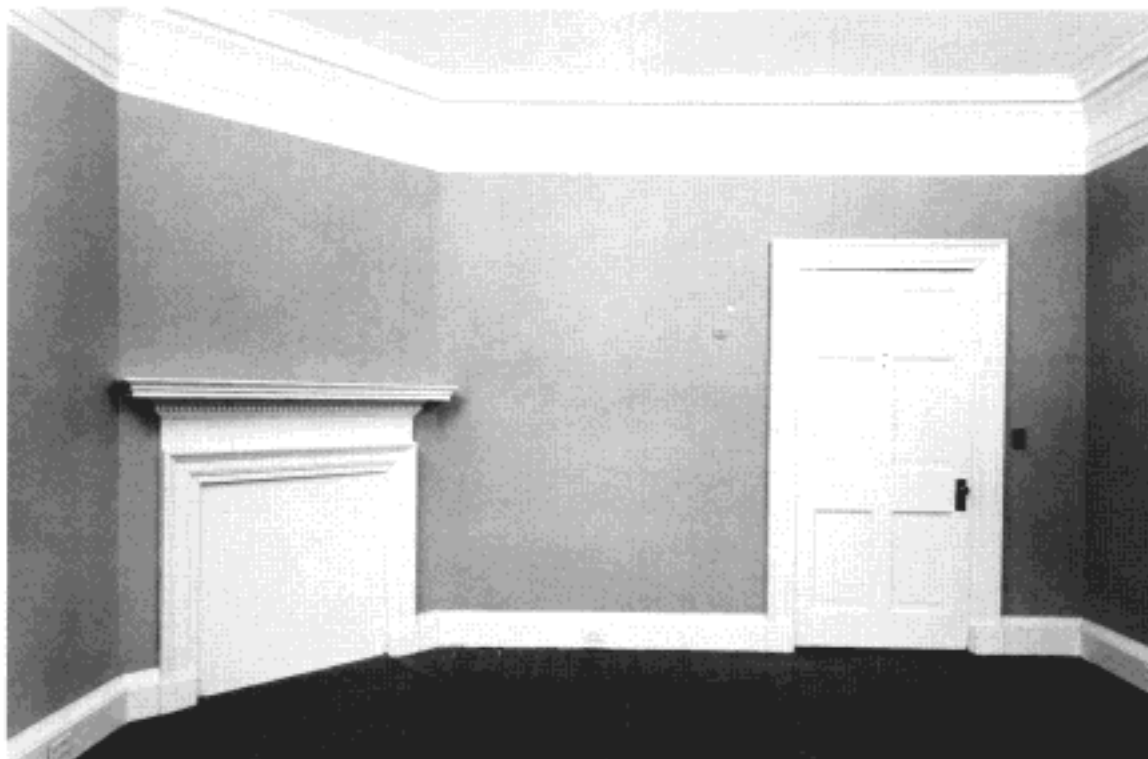

Room 204 Bedroom

Ceiling: Original plaster, painted, approximately 10' 8" above the floor.

Walls: The west and north walls are original plaster on brick masonry. The south and east walls are original plaster on wood lath. All of the surfaces are painted.

Baseboard: Original 8 $\frac{1}{2}$ "-high baseboard, including a 6"-high splashboard with a 2 $\frac{1}{2}$ "-high molded top (Type B-2).

Cornice: Original 1' 7 $\frac{1}{2}$ "-high wood entablature with a two-fascia architrave, a plain frieze, and an unornamented cornice (Type C-2).

Doors: One original doorway in the south wall with a 6 $\frac{1}{2}$ "-wide two-fascia architrave (Type T-35).

No. 2041: Original 1 $\frac{3}{8}$ " thick stile-and-rail door with six raised panels (Type D-22). Hardware: Pair of original 5" iron butt hinges and a circa 1929 5 $\frac{1}{2}$ "-high brass or bronze mortise lock stamped "P 10." Each side has a brass or bronze 7" escutcheon plate and 2 $\frac{1}{2}$ " diameter knob. The door originally had a 5"-high mortise lock.

A break in the baseboard on the east wall indi-

cates that there may have been a doorway in the east wall, as shown on the Jefferson floor plan.

Windows: Two original windows in the west wall and two original windows in the north wall, with splayed, paneled reveals and paneled heads. Each window is framed with a 6 $\frac{1}{2}$ "-wide two-fascia architrave (Type T-36) terminating at splashboard-height plinths. The reveals are divided at the level of the meeting rails and each portion has a tall, thin rectangular panel with a small square panel above. Each window has original 6/6 double rope-hung sash, with 12" by 18" panes, $\frac{3}{16}$ " muntins, and a twentieth-century sweep thumb latch on the meeting rails. The section of thumb latch on the upper sash of the northwest window is missing. All of the brass-faced sash pulleys are original.

Fireplace: The original chimney breast extends diagonally across the southeast corner of the room and is approximately 5' 4" wide. The surround and firebox opening have been plastered over; the plaster is painted white. The original wood surround consists of a 6 $\frac{1}{2}$ "-wide two-fascia architrave. Above

PAVILION V

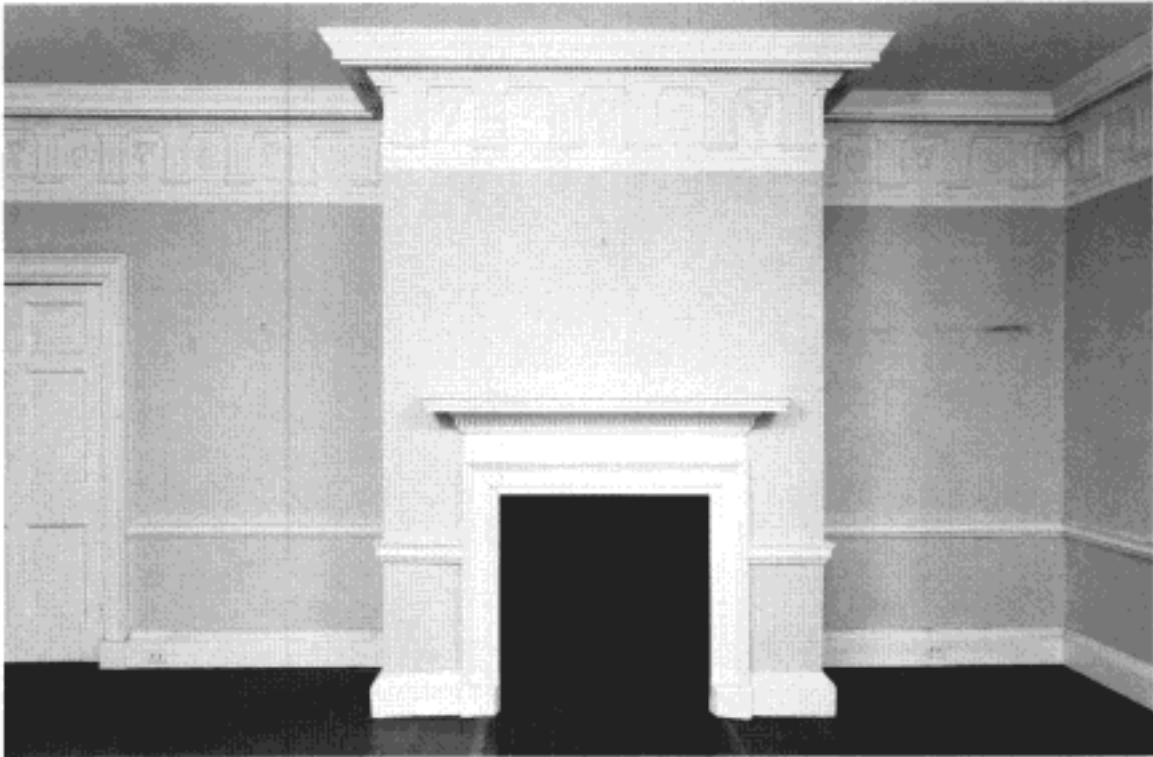

Room 205 Master bedroom

the architrave is a 5½" plain frieze and a 7" denticulated cornice supporting a mantel shelf. The hearth is laid with 2¼" by 8" bricks dating to the twentieth century.

Heating: One three-column, 18-section, cast-iron hot-water radiator is located between the two west windows. The radiator is marked "American Radiator" and "Peerless."

Lighting: There is no artificial lighting in the room. A circular metal plate on the south wall marks the location of a wall fixture. Other electrical elements include a switch with plastic switch plate west of door 2041 and five duplex receptacles in the baseboard. A junction box with a grounded duplex receptacle is mounted to the north wall near the northwest window. Rigid metal conduit runs from this box east to a similar outlet in Room 203.

Paint Investigation: The wood trim, including the mantel, was originally finished with yellowish white (2.5Y9/2) paint. The second finish on the mantel was a glossy black paint, typical of mantels in the 1820s and 1830s. The vertical face of the baseboard

and the plinth blocks were originally finished with a red-brown (10R3/2). The same color was used on the top surface of the mantel shelf.

The paneled door was grained to imitate mahogany.

Evidence on the plaster walls indicates that wallpaper was the original finish there followed by a cream-beige (10YR9/2) paint.

ROOM 205 MASTER BEDROOM (ORIGINAL PARLOR)

This large elegant room originally served as the private parlor of the professor who occupied the pavilion. The architectural detailing used here is the finest found in any of the original rooms. In general, the appearance of the room is very much like that of the corresponding second floor space in Pavilion I. Originally the room received natural light from three windows, but two windows were converted into doorways when the rear addition was enlarged in the early twentieth century. The

ARCHITECTURAL DESCRIPTION



Room 205 Master bedroom

two original doors open to the stair hall and the central hall.

The decorated entablature and the elegant fireplace are the most prominent features in the room.

The room retains all of the elements shown on Jefferson's original second floor plan except that the two windows in the west wall have been replaced with doors; and it appears that a cast-iron Franklin stove was never installed. A full fireplace was constructed as part of the original building.

Floor: Original random-width tongue-and-groove boards, running north-south, stained and varnished.

Ceiling: Original plaster, painted, approximately 10' 8½" above floor.

Walls: The north, south, and west walls are original plaster on brick masonry. The east wall is original plaster on wood lath. The west wall was originally an exterior wall. Additions were constructed beyond the west wall circa 1850 and circa 1903/1929.

Baseboard: Original 8¼"-high baseboard, including a 6"-high splashboard and a 2¼" molded top

(Type B-2).

Chair Rail: Original 4"-high wood rail (Type T-42).

Cornice: Original 1' 11"-high Doric entablature with a single-fascia architrave, a frieze with triglyphs and metopes ornamented alternately with bucrania and rosettes made of a terra-cotta composition, and a cornice. Several of the terra-cotta rosettes are missing. The cornice soffit is ornamented with mutules over the triglyphs lozenge-shaped geometric ornaments (flush with the mutules) of terra cotta over the metopes.

Doors: One original doorway in the north wall and one original doorway in the east wall, each with a 6¼"-wide two-fascia architrave (Type T-37). The north opening has a paneled reveal. Twentieth-century doors have been installed in the two original window openings in the west wall. The openings are framed with original 6¼"-wide two-fascia architraves (Type T-37) terminating at splashboard-height plinths. The reveals are divided at the level of the meeting rails and each portion has a tall,

PAVILION V

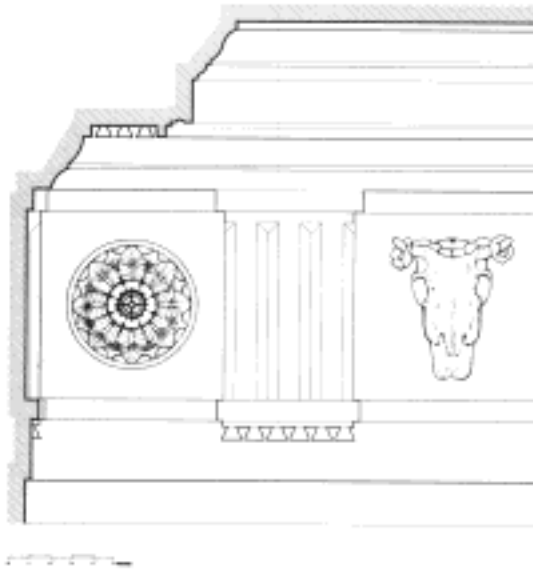

Detail of cornice, Room 205

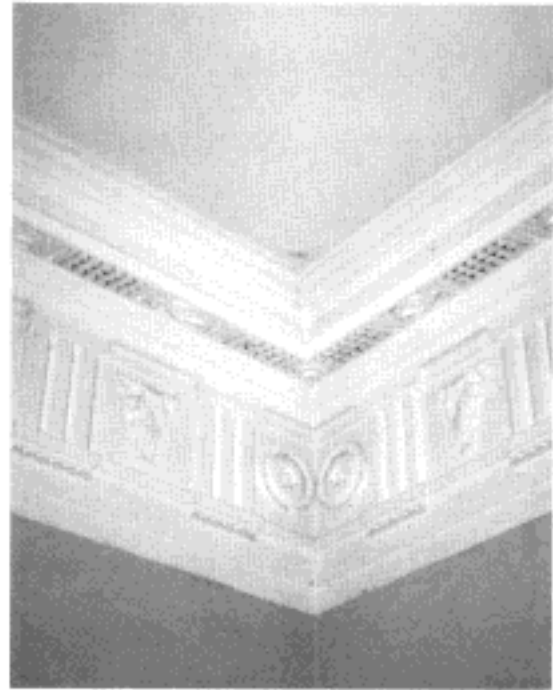

Cornice, Room 205

thin, rectangular panel with a small, square panel above.

No. 2051: Original $1\frac{3}{8}$ " thick stile-and-rail door with six raised panels (Type D-22). Hardware: Original pair of 5" iron butt hinges and a circa 1929 $5\frac{1}{4}$ "-high brass or bronze mortise lock stamped "P 10." Each side has a brass or bronze 7" escutcheon plate and $2\frac{3}{4}$ " diameter knob. The door retains evidence for a 5" to 6"-high mortise lock and possibly a box lock that may have been an earlier temporary fitting.

No. 2052: Original $1\frac{3}{8}$ " thick stile-and-rail door with six raised panels (Type D-22). Hardware: Original pair of 5" iron butt hinges and a circa 1929 $5\frac{1}{4}$ "-high brass or bronze mortise lock stamped "P 10." Each side has a brass or bronze 7" escutcheon plate and $2\frac{3}{4}$ " diameter knob. The door retains evidence of a 5"-high mortise lock as well as of a $4\frac{1}{2}$ " by 7" box lock. The box lock may have been used temporarily prior to the installation of the mortise lock.

No. 2053: Twentieth-century pair of $1\frac{3}{8}$ " thick stile-and-rail doors with two raised panels in each leaf (Type D-23). Hardware: Pair of 3" hinges at each leaf and a $5\frac{1}{4}$ "-high brass or bronze mortise

lock stamped "P 10" in the south leaf. Each side of the south leaf has a brass or bronze 7" escutcheon plate and $2\frac{3}{4}$ " diameter knob. The north leaf has a $4\frac{1}{2}$ "-high brass or bronze slide bolt on the bottom rail and a 5"-high iron slide bolt on the top rail. These doors and their hardware may date to circa 1929.

No. 2054: Twentieth-century pair of $1\frac{3}{8}$ " thick stile-and-rail glazed doors (Type D-25). Each leaf has twelve lights, with $5\frac{1}{2}$ " by $8\frac{1}{2}$ " panes and $\frac{3}{4}$ " muntins. Hardware: Pair of 3" hinges at each leaf and a $5\frac{1}{4}$ "-high brass or bronze mortise lock stamped "P 10" in the south leaf. Each side of the south leaf has a brass or bronze 7" escutcheon plate and $2\frac{3}{4}$ " diameter knob. The north leaf has a 5"-high iron slide-bolt surface mounted to the top and bottom rails. These doors and their hardware may date to circa 1929.

Windows: One original window in the south wall, with splayed, paneled reveals and paneled head. The window is framed with a $6\frac{3}{4}$ "-wide two-fascia architrave (Type T-38) terminating at splashboard-height plinths. The reveals are divided at the level of the meeting rails, and each portion has a tall,

ARCHITECTURAL DESCRIPTION

thin, rectangular panel with a small square panel above. The window has original 6/6 double rope-hung sash, with 12" by 18" panes and $\frac{9}{16}$ " muntins. Hardware includes a twentieth-century sweep thumb latch on the meeting rails. The brass-faced sash pulleys are original.

The two door openings in the west wall were originally windows that matched the extant window in the south wall. The openings were converted into doorways in the twentieth century.

Fireplace: The original 7' 1½"-wide chimney breast projects 2' 2½" from the north wall. The sides and floor of the firebox are constructed of 4¼" by 9" bricks, marked "Penn," while the back of the firebox is constructed of 2⅜" by 8¾" bricks. The entire firebox and brick surround are painted black. The surround is bordered by a 7"-wide two-fascia wood architrave below a 4¾" plain frieze and a 7¼" denticulated cornice supporting a mantel shelf. The wood mantel is original. There is a brick hearth projecting 2' 1" from the mantelpiece. The bricks are approximately 2¼" wide by 8" long.

Heating: A three-column, 18-section cast-iron hot-water radiator is located against the west wall. The radiator is marked "American Radiator" and "Peerless."

Lighting: There is no artificial lighting in the room. Electrical elements include a switch with plastic switch plate north of door 2051, a similar switch south of door 2053, and five duplex receptacles in the baseboard. A grounded duplex receptacle in the south wall, to the west of the window, probably serviced a window air conditioning unit.

Other Features: A small, square, tapered hole in the architrave of the entablature on the east wall (adjacent to the northeast corner) may indicate the position of a crank for part of a house bell system. There is a small hole in the flooring directly beneath this feature. The former second floor parlor of Pavilion II retains part of an original house bell system.

Paint Investigation: The first finish applied to the wood trim, including the elaborate entablature and the mantelpiece, was a yellowish white (2.5Y9/2) paint. The top surface of the chair rail and the vertical face of the baseboard were covered with a red-brown (10R3.2) paint.

The doors were grained to imitate mahogany.

Evidence of wallpaper was found as the original finish on the plaster walls. This was followed by the application of a light beige (2.5Y8.5/4) paint and a medium blue paint.

ROOM 206 VESTIBULE

As completed circa 1850, the second floor of the rear addition connector or hyphen consisted of a single room that consisted of what is now Room 206, 206A, and 206B. Prior to the extensive enlargement of the hyphen circa 1903/1929, the roof and ceiling height were lower; they were approximately level with the top of the doorway in the west wall.

Access to the space, whose function remains unknown, was from the doorway (originally a window) in the east wall, which opened to the second floor hall of the 1819-23 pavilion. Because of the difference in floor levels between the original pavilion and the hyphen, several steps were needed to descend into this room. At the west end of the room a door opening provided access into the stair hall of the rear addition. The original room may have functioned simply as a convenient connector hallway between the original pavilion and the rear addition or it may have served as a sort of porch.

Evidence in the south wall for a large window opening, perhaps for a tripartite window, indicates that the room received ample natural light. Modifications to the north wall make it impossible to determine if a similar opening was located there.

When the roof was raised circa 1903/1929, a pair of French doors was installed in the north wall. At the same time, or soon after, partitions were inserted and the floor was raised at the east end. Eventually the room was divided into a small vestibule (206) and two bathrooms (206A and 206B), which served the separate front and rear residences.

Floor: The narrow, circa 1903/1929, tongue-and-groove flooring extends to the east wall in what is now Bathroom 206B.

Ceiling: Circa 1903/1929 plaster on sawn lath, 8' 8" above the floor. The roof and the ceiling were rebuilt circa 1903/1929.

Walls: The north, south, and west walls are plaster on brick masonry. The east wall of the vestibule was plaster on sawn wood lath; it was removed in 1992. The north and south masonry walls date to circa 1850. Additional brick above the head height of the door was installed when the roof was raised circa 1903/1929. The east partition was constructed circa 1903/1929 as part of the extensive enlargement of the connector.

The removal of the east partition revealed evidence of an original, wide opening centered in the south wall, approximately 6' 9" wide and 6' 10" high. It may have contained a tripartite sash arrange-

PAVILION V

ment that extended from the floor to the height of the original, circa 1850 exterior cornice. The opening was closed when the roof was raised and the connector was extended to the south circa 1903/1929.

Baseboard: There is a 5¼"-high splashboard with flush bead at top edge (Type B-4) on the west wall and a circa 1903/1929 7¼"-high splashboard, including 1½" molded top and shoe molding (Type B-3) on the north wall.

Doors: One circa 1903/1929 door opening in south wall with a 4½"-wide single-fascia architrave (Type T-39). An original, circa 1850 opening in the west wall is framed with a 3"-wide beaded trim (Type T-32); the reveal is faced with wood.

Lighting: A lighting fixture is mounted at the approximate center of the ceiling.

Other Features: A closet with shelving was constructed at the north end of the space sometime after the circa 1903/1929 remodeling. At a much later date a smaller closet was constructed in the southeast corner of the vestibule.

Paint Investigation: The plaster walls of the original room (including spaces 206A and 206B) were covered with wallpaper. A very small fragment of paper was discovered on the north wall surface. The paper had been covered by the later construction of the east partition; this partition was removed in 1992. The room remained papered until the ceiling and roof were raised circa 1903/1929. At that time the plaster was painted a gold/tan (7.5YR8/4) color. The wood trim retains layers of yellowish white (2.5Y9/2) paint.

ROOM 206A BATHROOM

Floor: Narrow tongue-and-groove flooring dating to the twentieth century that replaced the original, circa 1850 flooring. This floor extends into Room 206 and beneath the raised floor of Room 206B.

Ceiling: Circa 1903/1929 plaster on sawn lath, 8' 8" above the floor.

Walls: The north and south walls are circa 1850 plaster on brick masonry. The east and west walls were removed in 1992. The west partition was plaster on sawn wood lath, circa 1903/1929, and the east partition was plaster on expanded metal lath, circa 1929 or later.

Baseboard: 7⅝"-high splashboard with molded top (Type B-3).

Doors: Pair of circa 1903/1929 glazed doors in north wall, framed with a 4½"-wide single-fascia ar-

chitrave (Type T-39). The interior faces of the doors are painted pink, and the exterior faces are painted white. A door in the west partition was removed in 1992.

No. 206A1: Pair of circa 1903/1929 1⅜" thick stile-and-rail glazed doors (Type D-29). Each leaf has 21 lights, with 5" by 7½" panes and ¾" muntins. There is a single raised panel below the glazing. Hardware: Each leaf has a pair of 3" butt hinges. The east leaf has a ¾" by 4" box lock marked "Rye Co. USA," porcelain knobs, a metal keyhole escutcheon, an escutcheon and keyhole remaining from a previous latch, and two slide bolts. The west leaf has a keeper marked "1888" and three slide bolts (two at the base and one at the top).

Windows: The glazed doors allow natural light to enter this space. The removal of the east and west partitions revealed evidence of an original window opening centered in the south wall, approximately 6'9" wide and 6'10" high.

Heating: Three-column, five-section ornamented, cast-iron hot-water radiator is located west of door 206A1. There are no manufacturer's marks on the radiator.

Lighting: A chrome and glass lighting fixture is mounted to the ceiling near the center of the room.

Plumbing: The plumbing fixtures removed from this room in 1992 include one vitreous china toilet from the east wall, marked "Wellworth 11098 7 24 61 3"; one enameled, cast-iron lavatory from the east wall, marked "Kohler USA, 7 24 61, 2701-19x17-17S"; and an enameled, cast-iron bathtub marked "Kohler USA, S16-5 2S, 7 26 61." The manufacturers' dates on these fixtures reveal that they were installed in 1961 or later.

Other Features: Before the 1992 renovation there was a two-door cabinet surface mounted to the west wall.

ROOM 206B BATHROOM

Floor: ¾"-wide pine subflooring, running east-west. The floor is approximately 7" below the floor level of the original pavilion. Remnants of grout from a tile floor (removed in 1992) remain on the surface. This floor was constructed above the floor surface in Rooms 206 and 206A circa 1929 or later.

Ceiling: Painted plaster, 7' 1" above floor. This surface dates to circa 1903/1929.

Walls: The east wall is plaster on original, 1819-23 masonry. This surface was originally part of the rear exterior wall of the pavilion. The north wall is

ARCHITECTURAL DESCRIPTION

plaster on brick masonry. Part of the plaster has been removed from the south wall, revealing expanded metal lath over roughly finished brick, similar to the brick on the north wall in Room 210. The west wall is plaster on expanded metal lath. Above the bathtub, the west wall is finished with 4¼" white ceramic tiles, set in grout on expanded metal lath.

Baseboard: A twentieth-century 6"-high splashboard on north, east, and west walls.

Doors: One door in the east wall with a 6"-wide two-fascia architrave surround. This opening was originally the west window opening of the central second-floor hall (Room 202) of the pavilion. It was converted into a doorway when the rear addition was constructed circa 1850.

Windows: One twentieth-century window opening in north wall, with a 6"-wide two-fascia architrave surround terminating on a 1" thick sill above a 4¼"-high two-fascia apron. The casement sash opens to the north, hangs from the east jamb on two 3½" butt hinges, and is secured with a small brass latch. The sash has nine 5" by 7½" panes with ⅝" muntins.

Heating: One four-column, twelve-section, cast-iron hot-water radiator sits between the two east windows. The radiator is marked "National."

Lighting: Electrical elements include wiring for a wall fixture on the east wall and a switch on the east wall.

Plumbing: The plumbing fixtures removed from this room in 1992 include one white vitreous china toilet from the west wall, dated "December 1979" on the inside of the tank lid; one white vitreous china lavatory from the east wall, marked "Kohler USA" and "K2006 17 8114 7 1 [?]" ; and an enameled, cast-iron bathtub with "11 6805 2-4 6247" marked in chalk.

Supply lines to the lavatory protrude through east wall, and supply lines to the bathtub and shower protrude through the floor. The supply line to the toilet remains in the west wall, and the capped-off waste line remains in the floor.

Other Features: Recessed medicine cabinet with mirrored door on east wall. Chrome towel rack on south wall. Chrome shelf brackets on east wall. Ceramic towel rack and soap dish and wood curtain rod in bathtub area. Chrome "Marathon Tissue" toilet paper holder south of toilet.

A 9½"-deep by 1' 4"-wide by 4' 4"-high wood cabinet was removed from the north wall in 1992. The cabinet was supported by carved wood brackets and had a door hung on butterfly hinges opening onto four shelves.

ROOM 207 STORAGE

This room and the adjoining bathroom (208) were created circa 1903/1929 when the roof was raised above the circa 1850 connector. The original function of the room is unknown; most recently, it served as a store room.

Floor: Original, circa 1903/1929 tongue-and-groove boards, running east-west, stained and varnished.

Ceiling: Circa 1903/1929, painted plaster on sawn wood lath, 8' 9" above floor.

Walls: The north and west walls are circa 1903/1929 plaster on circa 1850 brick masonry; the east wall is circa 1903/1929 plaster on sawn lath. The south wall is plaster on circa 1903 brick masonry.

Baseboard: Original, circa 1903/1929, 7¾"-high splashboard, including 1½" molded top and shoe molding (Type B-3).

Doors: One circa 1903/1929 doorway in north wall with a 4½"-wide single-fascia architrave surround (Type T-39).

No. 2071: Circa 1903/1929 1¼" thick stile-and-rail door with four raised panels (Type D-27). Hardware: Original pair of 3" butt hinges, a 3¼" by 3¾" iron box lock with brass knobs, a small metal keyhole escutcheon, and two brass hooks.

Windows: One original, circa 1903/1929 window in south wall with 6"-wide two-fascia architrave (Type T-26) terminating on a 1¼" thick bullnosed sill above a 3"-high apron. The apron is finished with a flush bead at the bottom edge. The opening has 6/6 double rope-hung wood sash with 10" by 14" panes, ⅝" muntins, and a sweep thumb latch on the meeting rails. The sill is covered with marbled vinyl film.

Heating: Three-column, seven-section, cast-iron hot-water radiator located immediately east of the window. There are no manufacturer's marks on the radiator.

Lighting: There is a box lighting fixture mounted to the ceiling near the center of the room. Other electrical elements include a switch and duplex receptacle in the north wall and a duplex receptacle in the baseboard of the pipe chase.

Plumbing: A 1' 4"-wide pipe chase in the southeast corner of room contains a waste line and a domestic water line. This chase is contemporary with the construction of the room.

Other Features: Television coaxial cable extends through a hole in the window sill.

PAVILION V

ROOM 208 BATHROOM

This room was created when the circa 1850 connector was enlarged, circa 1903/1929. At that time rooms were added to the south side of the connector at the basement, first-floor, and second-floor levels. This room has probably always functioned as a bathroom. The plumbing vent pipe in the southeast corner of the adjoining room (207) is an original feature of the circa 1903/1929 addition. Although there is another floor surface beneath the existing bathroom floor, evidence reveals that the lower surface was never used. None of the wall surfaces below the existing bathroom floor has evidence for any form of finish.

All existing bathroom fixtures were installed after the middle of the twentieth century.

Floor: Original, circa 1903/1929, 3¼"-wide tongue-and-groove flooring, running east/west. Remnants of grout from a tile floor, recently removed, remain on the floorboards. This floor is approximately 7" below the floor level of the original pavilion. The bathroom floor is constructed above a tongue-and-groove floor that is at the same level as the floor in Room 207. Physical evidence (lack of plaster on the brick wall surfaces and on the west stud wall below the level of the current floor) indicates that the lower floor was never used.

Ceiling: Painted plaster, 7' 1" above floor. The circa 1903/1929 wood lath and plaster ceiling is covered by a later surface of plaster on expanded metal lath.

Walls: The east wall is circa 1903/1929 plaster on original 1819-23 brick masonry. Before this room was constructed, this would have been the rear exterior wall of the original pavilion. The north and south walls are plaster on masonry. The north brick surface was the exterior (south) wall of the circa 1850 connector. The upper eight brick courses were exposed when the connector was enlarged and the roof and cornice were raised circa 1903/1929. The original circa 1850 window opening of the connector can be seen in this wall; it has been crudely filled with brick (some reused brick with white paint). The west wall is plaster on expanded metal lath. The original circa 1903/1929 plaster was removed when the metal lath was installed. A plaster-on-lath wing wall was constructed when the bathroom was installed. The walls above the bathtub are faced with 4¼" square white ceramic tiles.

Baseboard: 5½"-high splashboard. The splash-

board does not extend across the bathroom alcove, nor does it run beneath the door threshold. A quarter-round shoe molding runs along the fascia board beneath the threshold.

Doors: One doorway in the original pavilion window opening in the east wall, with a 6¼"-wide two-fascia architrave surround.

Windows: One circa 1903/1929 window opening in the south wall, with a 6"-wide two-fascia architrave terminating on a 1" thick bullnosed sill, approximately 7" above the floor. The original, circa 1903/1929 6/6 double rope-hung window sash have 10" by 14" panes, ⅝" muntins, and a sweep thumb latch on the meeting rails.

Heating: One four-column, 21-section, cast-iron hot-water radiator is located against the north wall. The radiator is marked "National."

Lighting: Wiring remains in the ceiling for a light fixture (removed in 1992).

Plumbing: The plumbing fixtures removed from this room in 1992 include one white vitreous china toilet from the west wall, dated "December 1979" on the inside of the tank lid; one enameled, cast-iron lavatory from the east wall, marked "Kohler USA, 2700, 22 x 10-4-9" and "2 1 52 D"; and an enameled, cast-iron bathtub with "3 6288 2-1 6305" marked in chalk.

There are supply pipes and a waste pipe in the east wall, a water-supply pipe to the toilet in the west wall, a waste line in the west end of the floor, and hot-and-cold-water lines in the floor at the former location of the bathtub.

Other Features: Recessed medicine cabinet with mirrored door in east wall. Chrome soap dish on east wall. Chrome towel racks on south wall and on south face of the bathtub wing wall.

A 9¼" deep by 3' 6" wide by 4' 4" high wood cabinet was removed from the east end of the north wall in 1992. The cabinet had a pair of doors hung on butterfly hinges.

ROOM 209 REAR STAIR HALL

This hall duplicates in plan the first floor stair hall (107) directly below. Evidence of the original, circa 1850 finishes survives, but some changes and additions were made in the nineteenth and twentieth centuries.

The earliest modification was the creation of a doorway in the north wall. This doorway provided direct access to Room 210.

Circa 1903/1929, when the connector was en-

ARCHITECTURAL DESCRIPTION

larged, the small horizontal window opening was inserted in the south wall of the stair landing. An earlier window was possibly positioned in the east wall, but this would have been closed over when the connector was expanded to the south.

Although the paint layering on the trim of the door opening in the east wall has been disturbed and is difficult to analyze, it seems to indicate that opening was created or possibly enlarged when the connector was modified, circa 1903/1929.

Floor: Original, circa 1850 tongue-and-groove boards, running north-south, stained and varnished.

Ceiling: Painted plaster on metal lath, 8' 8" above the floor. This twentieth-century surface replaces the original plaster on split-wood lath.

Walls: The east, west, and south walls are of circa 1850 plaster on brick masonry. The north partition is of original plaster on wood lath.

Baseboard: Original 5½"-high splashboard with flush bead along the top edge (Type B-4).

Doors: Two original doorways in the west wall and one later doorway in the north wall, with 4¾"-wide single-fascia architrave surrounds (Type T-39). One original opening in the east wall with a 3½"-wide beaded surround (Type T-32).

No. 2091: 1½" thick stile-and-rail door with six raised panels (Type D-31). Hardware: Pair of 3" butt hinges and a 3¾" by 3¼" iron box lock with brass or bronze knobs. This door opening is a later, perhaps nineteenth century, insertion in the original wall. The door is original to this opening but does not match the circa 1850 four-panel doors to Rooms 211 and 212. The door was originally hinged to the west jamb so that it would swing into Room 210.

Windows: One window in the south wall of the stairwell with a 5"-wide single-fascia architrave surround (Type T-33). The rectangular, decorative pivoting sash has 25 lights, ¾" muntins, and a brass or bronze latch at the top of the sash. The opening and sash were installed circa 1903/1929 when the connector was enlarged. There may have originally (circa 1850) been a window in the east wall to light the stairway.

Lighting: There is no artificial lighting in the room. Wiring in the west wall between Doors 2111 and 2121 serviced a wall fixture removed in 1992. Other electrical elements include a double switch in the west wall and a grounded duplex receptacle in the north wall.

Equipment: Smoke detector above Door 2091.

Other Features: One post-1950 7' 4½"-high ply-

wood closet with two sliding flush doors. The closet is 2' 1" deep by 5' 0" wide. A 1½"-high beveled cornice trims the top of the cabinet.

On the stair landing, there is a shelving unit built across the width of the south wall. The unit has four levels of 7¼" deep shelves and measures 5' 0½" high including a 3" cornice. The unit extends up to the bottom architrave of the decorative, pivoting window. This shelving was installed in the twentieth century.

Paint Investigation: The original wood trim (circa 1850) was first finished with yellowish white paint, and it retains later finishes of the yellowish white (2.5Y9/2) paint. The baseboard was originally painted a gray (10YR6/1) color.

The doors were grained to imitate mahogany or oak.

The plaster wall surface retains traces of an original wallpaper. Since the wall surfaces of the second floor stair hall are continuous with those of the first floor stair hall (107), this wallpaper would have been the same paper that covered the walls below.

ROOM 209A CLOSET

The closet was created in the twentieth century when a partition was constructed at the south end of Room 210. At that time the closet door was made to swing outward into the stair hall. The partition was removed in 1992.

Floor: Original, circa 1850 tongue-and-grooved boards, running north-south, stained and varnished.

Ceiling: Original plaster on split-wood lath, 8' 8"(±) above floor.

Walls: The east and west walls are plaster on circa 1850 brick masonry. The later inserted north wall, which was removed in 1992, was 6" thick and was located 1' 11½" from the south wall. The south partition is of original plaster on wood lath. The doorway in the south wall is a later nineteenth-century insertion.

Baseboard: A section of original, circa 1850, baseboard survives on the south wall to the east of the doorway.

Doors: One doorway in the south wall with a 4¾"-wide single-fascia architrave surround (Type T-39). This opening was inserted sometime after the original construction of the wall.

Lighting: One porcelain utility incandescent fixture on the south wall, operated with a chain pull.

PAVILION V

ROOM 210 BATHROOM

In its circa 1850 form, this room could be entered only from bedchamber 211. It may have served as a dressing room for the occupant of that space. In the later nineteenth century, a doorway was inserted in the south wall so that the room could be entered directly from the stair hall. It has not been determined when the room was converted into a bathroom, but the most recent plumbing fixtures were placed here in 1961 or later. At some time in the twentieth century a partition was inserted at the south end of the room, thereby creating a closet (209A).

Floor: At the time of this survey (1992), the room was under construction and the floor could not be investigated.

Ceiling: Twentieth-century plaster on metal lath, 8' 8" (\pm) above the floor. The original, circa 1850 surface was plaster on split-wood lath.

Walls: The north, east, and west walls are plaster on metal lath on original, circa 1850 brick masonry. A 5" thick wing wall at the north end of the bathtub and a 6" thick partition dividing the bathroom from Closet 209A were removed in 1992. The south wall of the original room is of plaster on wood lath.

Baseboard: A 6"-high splashboard with flush bead at top edge.

Doors: One original doorway in west wall with 6"-wide two-fascia architrave surround (Type T-26). The door opening in the south wall is believed to be a later nineteenth-century insertion. The door was initially hinged so that it would swing into this room.

No. 2101: Original 1¼" thick stile-and-rail door with four recessed panels (Type D-26). Hardware: Pair of original 3" butt hinges and a 4" by 5" Carpenter-type iron box lock with pair of later brass knobs and an original 1¼" by 1¾" oval keyhole escutcheon. The Carpenter lock is original to this location and represents the lock type originally used on the doors of the circa 1850 addition. It is marked "Improved Rimlock No 60" and includes an eagle motif. The same type of lock survives in the circa 1850 rear addition at Pavilion I.

Windows: Original window in north wall with 6"-wide two-fascia architrave surround (Type T-26) terminating on a 1" thick bullnosed sill above a ¾" cavetto molding. The 6/6 double rope-hung sash has 12" by 14" panes and ⅙" to ⅝" muntins.

Heating: A three-column, ten-section cast-iron hot-water radiator is located below the window in the north wall. The radiator is marked "American Radiator."

Lighting: Electrical elements include a light fixture mounted near the center of the ceiling, a switch on the west wall, and a junction box for a light fixture on the west wall (removed in 1992).

Plumbing: The plumbing fixtures removed from this room in 1992 include one vitreous china toilet from the east wall, marked "Wellworth 788 7 21 61 6, K4522"; one enameled, cast-iron lavatory from the west wall, marked "Kohler USA, 7 17 61, 2071-19x17S"; and an enameled, cast-iron bathtub marked "Kohler USA." The supply and waste lines for the bathtub remain in the floor near the east wall.

Other Features: Recessed medicine cabinet with mirrored door, marked "Grote," on west wall. Chrome toilet-paper holder on north wall.

ROOM 211 BEDROOM

This large room has probably always functioned as a bedchamber and is one of four similar large chambers created when Professor Harrison had the rear addition and connector constructed circa 1850. As originally completed, there was a doorway in the south wall that connected this room with the similar adjoining chamber.

This room may have been of some importance since it had a small private room that could be entered only by the doorway in the east wall. At some later time a new doorway was created so that the small room could be entered from the stair hall.

Floor: Original, circa 1850 tongue-and-groove boards, running north/south, stained and varnished.

Ceiling: Original plaster on wood lath, painted, 8' 8" above floor.

Walls: Original plaster on brick masonry. There was originally a door in the south wall.

Baseboard: Original 5½"-high splashboard with flush bead along top edge and quarter-round shoe molding (Type B-4). A 3' 4"-wide break occurs in the south baseboard at the location of a previous door opening.

Doors: Two original doorways in the east wall with 6"-wide two-fascia architrave surrounds (Type T-26). An original 3' 0" (\pm) door opening in the south wall, located approximately 3' 6" from the east wall, has been filled in. The trim and door from this opening may be the material that was later used to make the door opening between Rooms 109 and 110.

ARCHITECTURAL DESCRIPTION



Room 211 Bedroom

No. 2111: Original 1 $\frac{1}{4}$ " thick stile-and-rail door with four recessed panels (Type D-26). Hardware: Pair of 3" butt hinges and a later 3 $\frac{1}{2}$ " by 3 $\frac{1}{4}$ " iron box lock with brass knobs and small metal escutcheon. The door was hinged originally to swing from the north jamb. Evidence on the lock rail indicates that there was originally a 4" by 6" box lock, probably a Carpenter-type lock.

Windows: Two original window openings, one in the north wall and one in the west wall, framed with 6"-wide two-fascia architraves (Type T-26) terminating on 1 $\frac{3}{4}$ " thick sills. Each opening has original 6/6 double rope-hung sash with 12" by 14" panes, $\frac{5}{16}$ " muntins, and a sweep thumb latch on the meeting rails.

Fireplace: The original brick chimney breast extends diagonally across the southwest corner of the room; it is approximately 6' 2" wide. A plaster surround is painted black and is framed at either end by plain wood pilasters applied to fascias. Above the pilasters, a 10"-high frieze supports a 2 $\frac{1}{2}$ "-high cornice and shelf. An original stone

hearth projects from the chimney breast. The wooden mantle is an original feature of the circa 1850 rear addition.

Heating: A four-column, 15-section ornamental, cast-iron hot-water radiator is located below the west window. There are no manufacturer's marks on the radiator.

Lighting: There is no artificial lighting in the room. Electrical elements include a switch in the east wall, duplex receptacles in the south wall and north baseboard, and a grounded duplex receptacle in the north wall.

Other Features: One post-1950 7' 3"-tall plywood closet with two sliding flush doors. The closet is 2' 1" deep by 4' 2" wide. A 2 $\frac{1}{2}$ " cymatium trims the top of the cabinet.

Paint Investigation: The wood trim was first finished with a yellowish white (2.5Y9/2) paint, and the baseboard was covered with a gray (10YR4/1) color. The mantel was finished in a glossy black paint, and the doors were grained, possibly to imitate oak.

PAVILION V

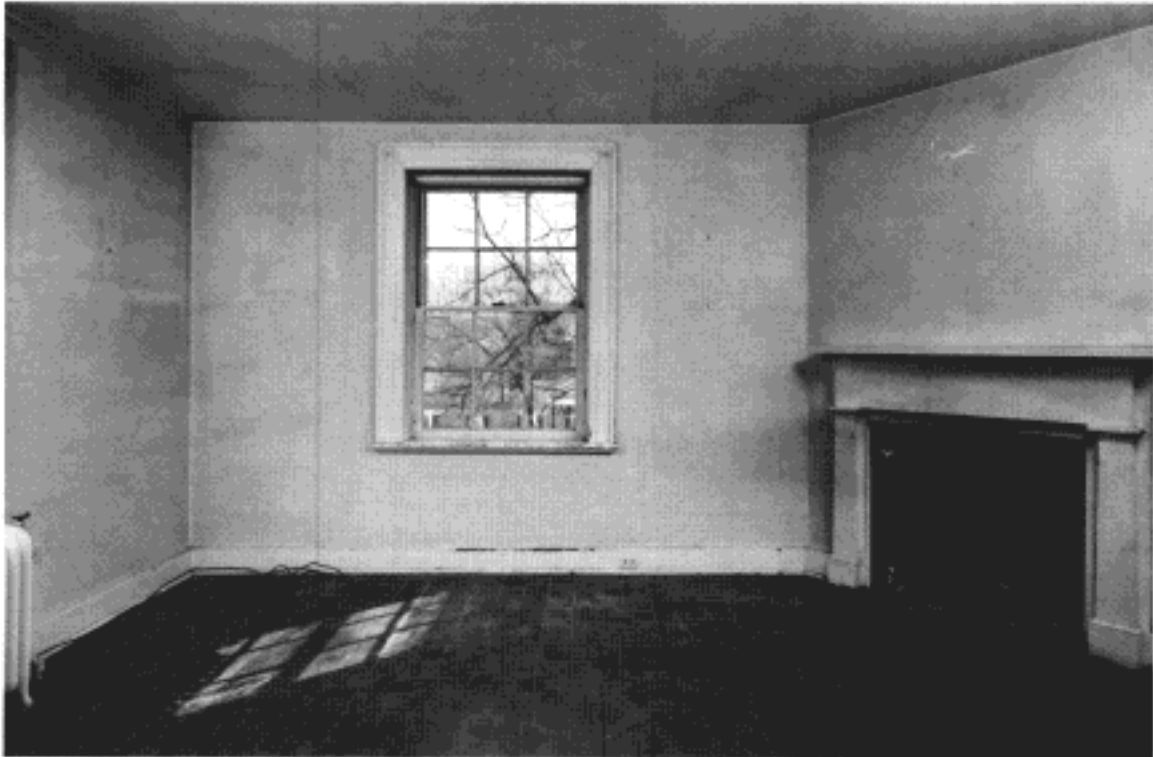

Room 212 Bedroom

Minute traces of wallpaper were found on the white plaster wall surfaces.

ROOM 212 BEDROOM

Since its completion circa 1850 this room has probably always served as a bedchamber. Originally, a doorway in the north wall connected this room to bedchamber 211. The latter room has two windows, while this room has three, two of which face to the south.

Floor: Original tongue-and-groove boards, running north/south, stained and varnished.

Ceiling: Original plaster on wood lath, painted, 8' 8" above floor.

Walls: Original plaster on brick masonry.

Baseboard: Original 6"-high splashboard with a flush bead along the top edge and a flattened shoe molding at the bottom edge (Type B-4).

Doors: One original doorway in east wall with 6"-wide two-fascia architrave surround (Type T-26). An original 3' 0"(\pm) door opening in the north wall, lo-

cated approximately 3' 6" from the east wall, has been filled in. The door and trim from this opening may have been used to create the doorway in the wall between Rooms 109 and 110.

No. 2121: Original 1 $\frac{1}{4}$ " thick stile-and-rail door with four recessed panels (Type D-26). Hardware: Original pair of 3" butt hinges and an antique 4 $\frac{1}{2}$ " by 6" iron Carpenter box lock with brass or bronze knobs; the lock and its knobs are not original to the door. There is evidence under the lock for a 4"-high by 3 $\frac{1}{4}$ "-wide box lock.

Windows: Three original window openings, two in the south wall and one in the west wall, with 6"-wide two-fascia architrave surrounds (Type T-26) terminating on 1 $\frac{1}{4}$ " thick sills. Each opening has original 6/6 double rope-hung sash with 12" by 14" panes, $\frac{3}{16}$ " muntins, and a recent sweep thumb latch on the meeting rails.

Fireplace: The original brick chimney breast extends diagonally across the northwest corner of the room; it is approximately 6' 2" wide. A plaster surround is painted black and is framed at either end

ARCHITECTURAL DESCRIPTION

by original plain wood pilasters applied to fascias. Above the pilasters a 10"-high frieze supports a 2¾"-high cornice and shelf. The original stone hearth projects from the chimney breast. The wooden mantel dates to the circa 1850 construction of the rear addition.

Heating: One three-column, 18-section, cast-iron hot-water radiator is located beneath the southwest window. The radiator is marked "American Radiator" and "Peerless."

Lighting: There is no artificial lighting in the room. Electrical elements include a switch in the east wall south of door 2121, two duplex receptacles in the baseboard, and two additional duplex receptacles in the north and south walls.

Other Features: A telephone jack is mounted to the east baseboard; station wire extends through the architrave of door 2121 and into the rear stair hall (Room 209).

Television coaxial cable extends through the architrave of the southwest window.

Paint Investigation: The original trim was first finished with a yellowish white (2.5Y9/2) paint, and the baseboard was covered with a gray (10YR4/1) finish. The wood mantelpiece was painted with a glossy black.

The door was grained, possibly to imitate oak.

The plaster-wall surfaces were first covered with wallpaper and later painted with a very pale blue (5B9/1) distemper.

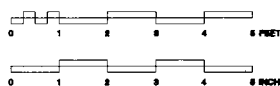
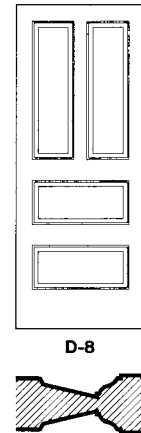
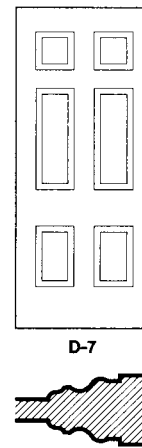
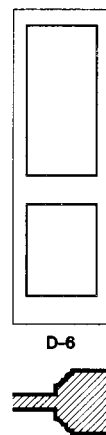
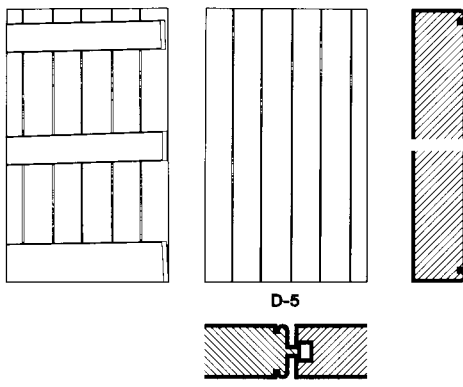
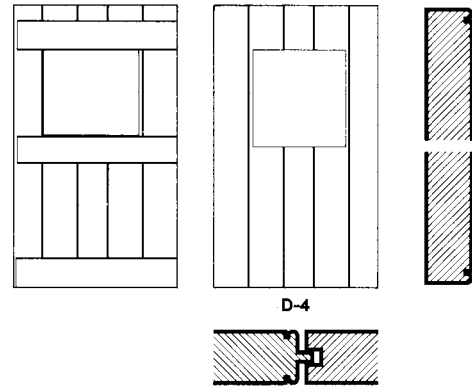
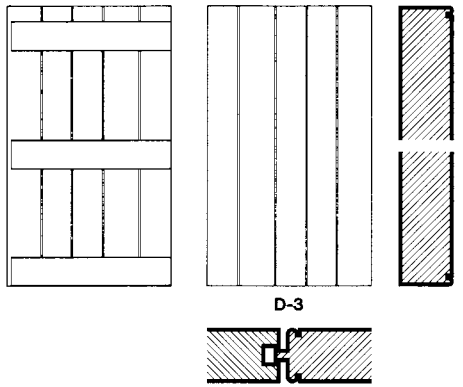
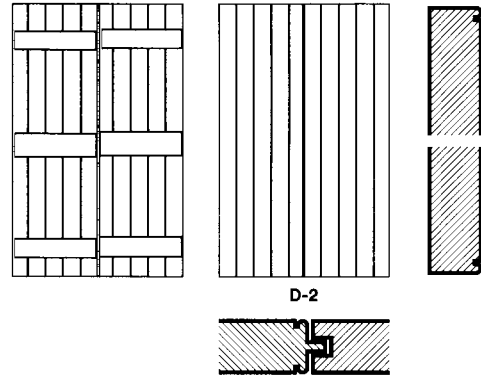
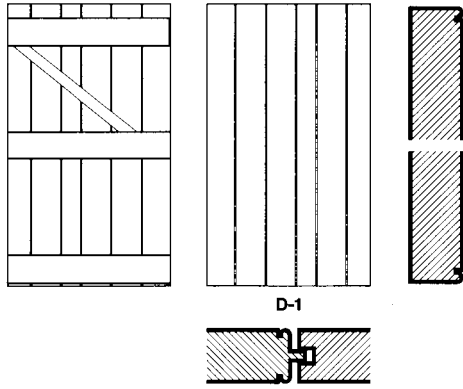

Elevation and profiles of door types

ARCHITECTURAL DESCRIPTION

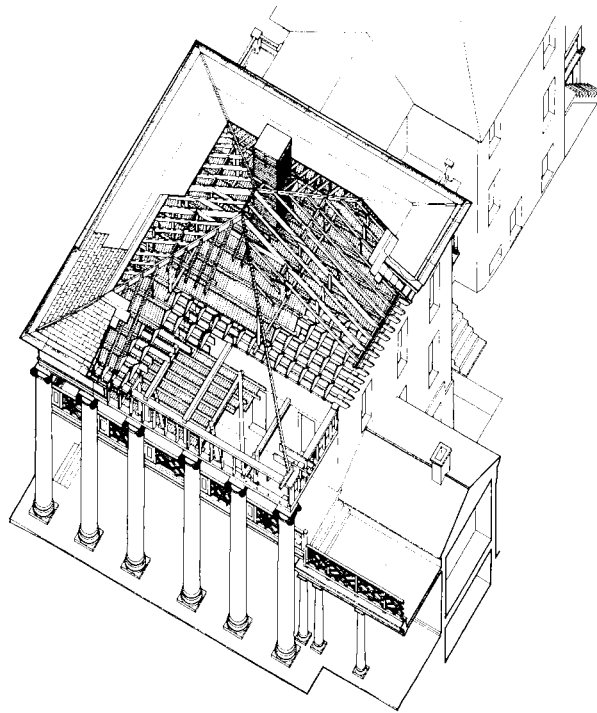

Axonometric drawing showing the frame construction of Jefferson's ridge-and-furrow roofing system, encapsulated by the 1837 hipped roof. The saw-toothed joists of the original roof were cut away at the perimeter of the building to accommodate the slopes of the new roof.

ATTIC

When completed in 1823, the pavilion did not have an accessible attic space between the second floor ceiling and the ridge-and-furrow roof. When the high, hipped roof was installed in 1837, the present attic space was created. The original access hatch, still in place in the second floor hall ceiling, connects the hall directly to the original roof surface and the later attic space; this feature was modified in 1993.

Because the original ridge-and-furrow roof remained in place, it is unlikely that the attic was used for storage. The "floor" was simply too irregular and difficult to walk on.

PAVILION V

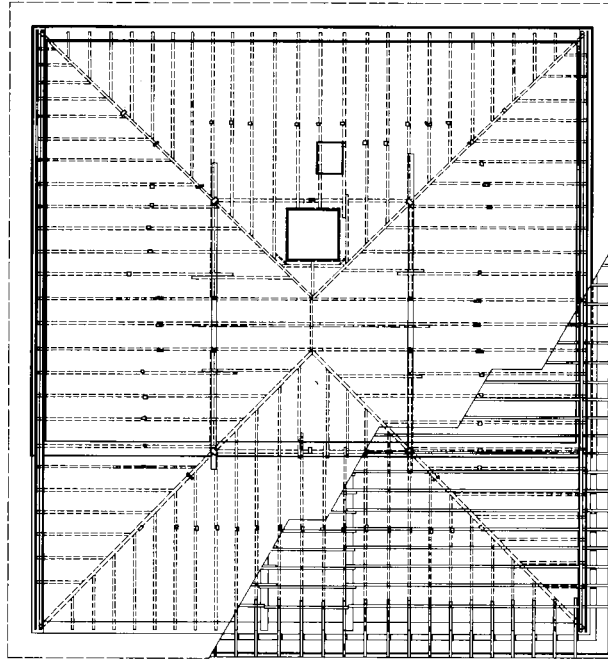

Roof plan showing the framing (in dashed lines) of the 1837 hipped roof.

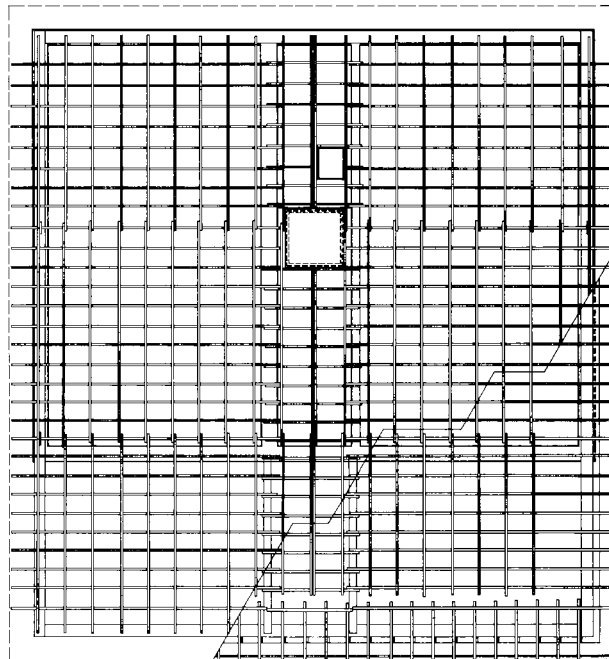

Roof plan showing the east-west saw-toothed joists of the ridge-and-furrow roofing system bearing on the north-south second floor ceiling joists. The cutaway reveals outrigger framing for the east cornice.

ARCHITECTURAL DESCRIPTION

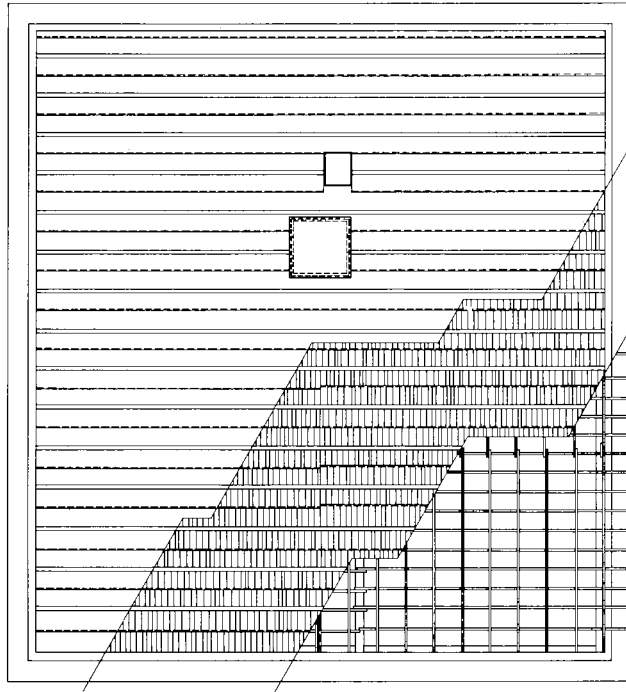

Roof plan showing the original configuration of the pavilion's ridge-and-furrow roof with a detailed view of the overlapping wood boards and a cutaway revealing the framing below.

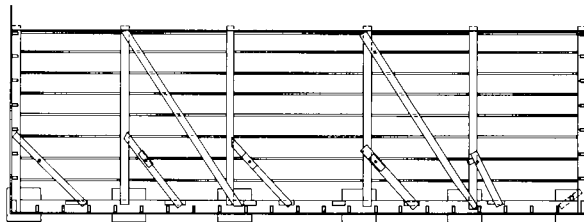

Plan showing the framing for the east porch ceiling. The short diagonal members support the wrought-iron rods from which the east edge of the porch is suspended.

PAVILION V

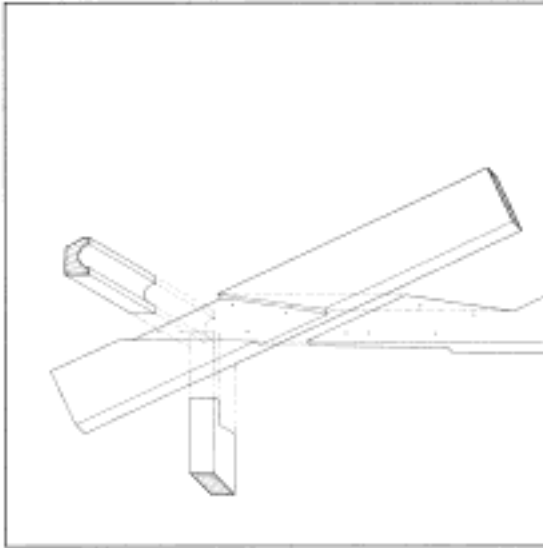

Exploded view of 1837 roof framing, showing lapped joint of collar tie and rafter with purlin and purlin post. The purlin was fabricated from a section of the pavilion's original wood gutter.

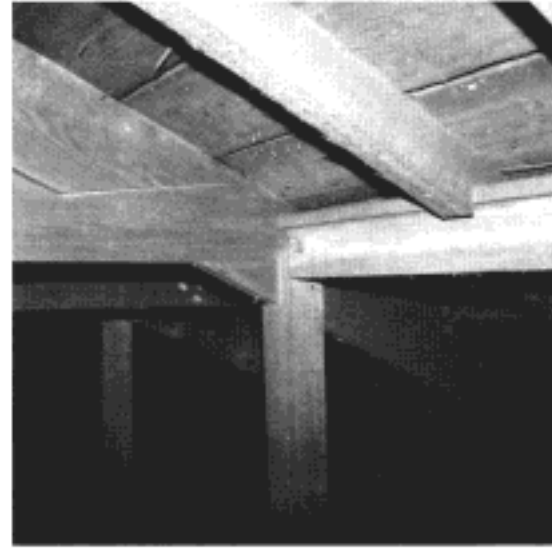

Original wood gutter reused as purlin in hipped roof

Floor: The floor of the attic is made up of the circa 1819-23 ridge-and-furrow roof. The old roof begins with 2" thick by 9 $\frac{1}{4}$ " to 12"-high ceiling joists running north-south, spaced 1' 2" to 1' 6" apart. Sawtooth roof joists, running east/west (ranging from 5" in the valleys to 12" high at the peaks, set 3' 0" apart), rest on the ceiling joists. Sheathing boards ($\frac{3}{4}$ " to 1 $\frac{1}{2}$ " thick) are applied to the sawtooth joists to form the base of the roof. At all four sides of the attic the sawtooth joists have been cut off to accommodate the circa 1837 hipped roof members; some of the cut pieces were used in the early twentieth century as supports for electrical knob-and-tube wiring. The valleys of the furrowed roof are finished with tinplate. Two layers of boards (5" to 6" wide by $\frac{3}{4}$ " thick) are laid north-south along the angles of the roof.

In the area above the east porch, the attic framing is made up of 1 $\frac{1}{2}$ " to 2" thick by 3 $\frac{3}{4}$ " to 5" high joists that support the porch's tongue-and-groove ceiling. The joists run north/south and are notched to tie into 6"- to 8"-wide by 5"-high beams running east-west. Five diagonal braces (running northeast to southwest), set on the beams, support

the wrought iron tie rods of the east porch. No flooring has been laid on the framing that supports the porch ceiling.

Ceiling: The attic ceiling is made up of the circa 1837 hipped roof built above the original ridge-and-furrow roof. Wood rafters 2" to 3 $\frac{3}{4}$ " wide by 3 $\frac{3}{4}$ " to 4" high and spaced approx 1' 10" to 2' 0" apart, on center, support 7"- to 14"-wide wood sheathing. Collar ties, 7 $\frac{1}{2}$ " deep, are set approximately 4' 6" above the bottom edge of the sawtooth joists and are fastened to the rafters with half-dovetail mortises and nails.

The structure of the shingled roof can be seen in the attic. Wood sheathing is fastened to the rafters. Along the north and south eaves of the roof, plywood has been fastened to the sheathing; the plywood may bridge the original rainwater diverter of the second roof. Above the sheathing, the roof is covered with asphalt building paper and slate shingles.

Walls: Knee walls (approximately 4' 6" high) supporting the hipped roof are constructed of studs spanning a plate resting directly on the ridges of the ridge-and-furrow roof and the rafters (where the collar beams are attached). At some locations, the top plate of the knee wall was constructed with sections of the original, circa 1819-23 wood gutter. The

ARCHITECTURAL DESCRIPTION



Original chimney stack extended through 1837 hipped roof

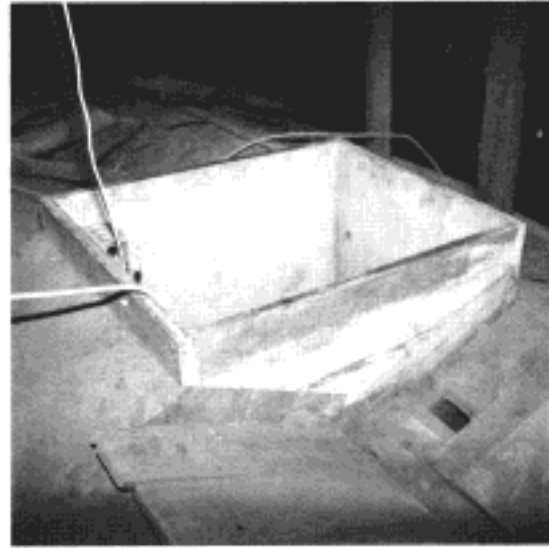

Jeffersonian roof hatch

height of the wood gutter ranges from 4 $\frac{3}{8}$ " on its back surface to 5 $\frac{5}{8}$ " at the front; it is 3 $\frac{3}{8}$ " thick with a 1 $\frac{1}{4}$ " diameter hollow.

Doors: The original 1819-23 hatch was greatly altered in 1992. The 2' 0" by 2' 5 $\frac{1}{2}$ " hatch was located 2' 4" west of the chimney, and was constructed of 1 $\frac{1}{2}$ " thick tongue-and-groove boards rising 1' 2" above the valleys of the 1819 roof. Original tinfoil flashing, now removed, was nailed to the hatch, and the tinfoil lining of the roof valley was soldered to the flashing. This was a rare example of Jefferson-era soldering.

Chimney: The chimney mass (4' 0 $\frac{1}{2}$ " by 4' 1 $\frac{1}{2}$ ") rises from the hall below. The chimney, now enclosed in the attic space, was at one time exposed and features finished mortar joints. The base of the chimney rises nine courses above the top of the joists and then steps back. The primary shaft of the chimney is approximately 4' 0" square, and extends straight for 16 courses. The next course is corbeled out $\frac{3}{8}$ "; this marks the top of the original (1819-23) chimney. When the new roof was added, the chimney was extended straight up from the corbeled cap.

Electrical/Lighting: Remnants of an old knob-and-tube electrical system remain in the attic.

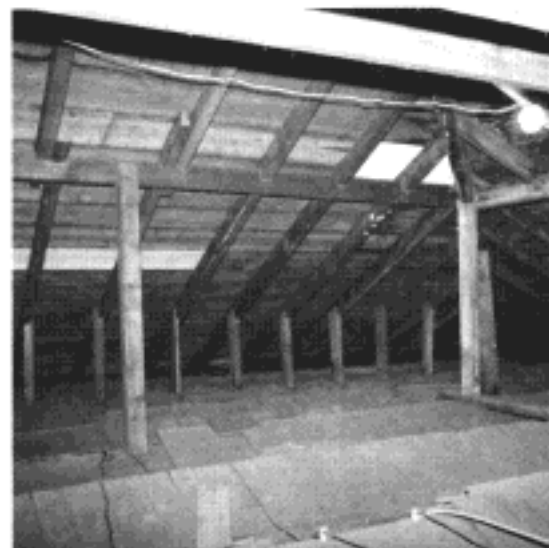

Jefferson's ridge-and-furrow roof, encapsulated beneath 1837 hipped roof

PAVILION V



Ridge-and-furrow roof clad with wood boards and tinplate valleys

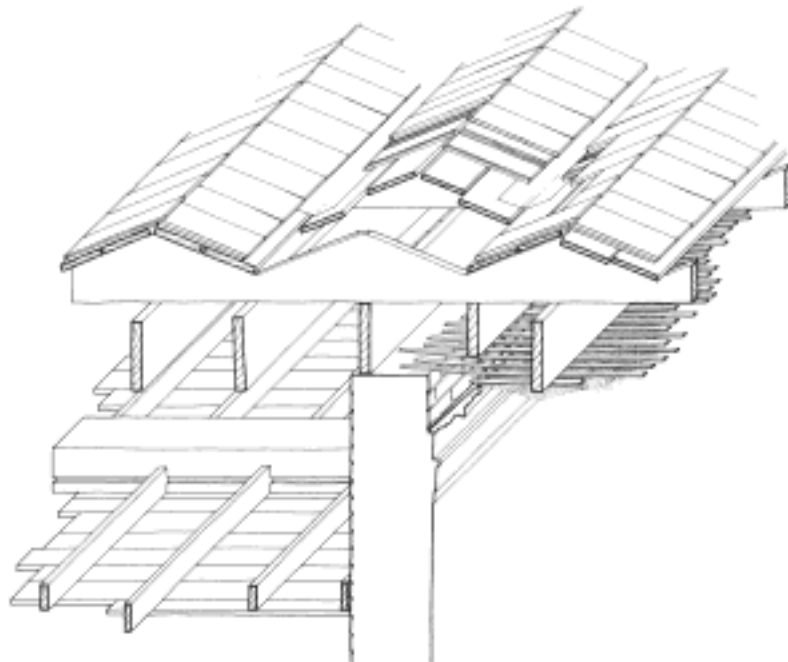

Axonometric drawing of ridge-and-furrow roofing system above framing of east porch ceiling and second floor study.

ARCHITECTURAL DESCRIPTION

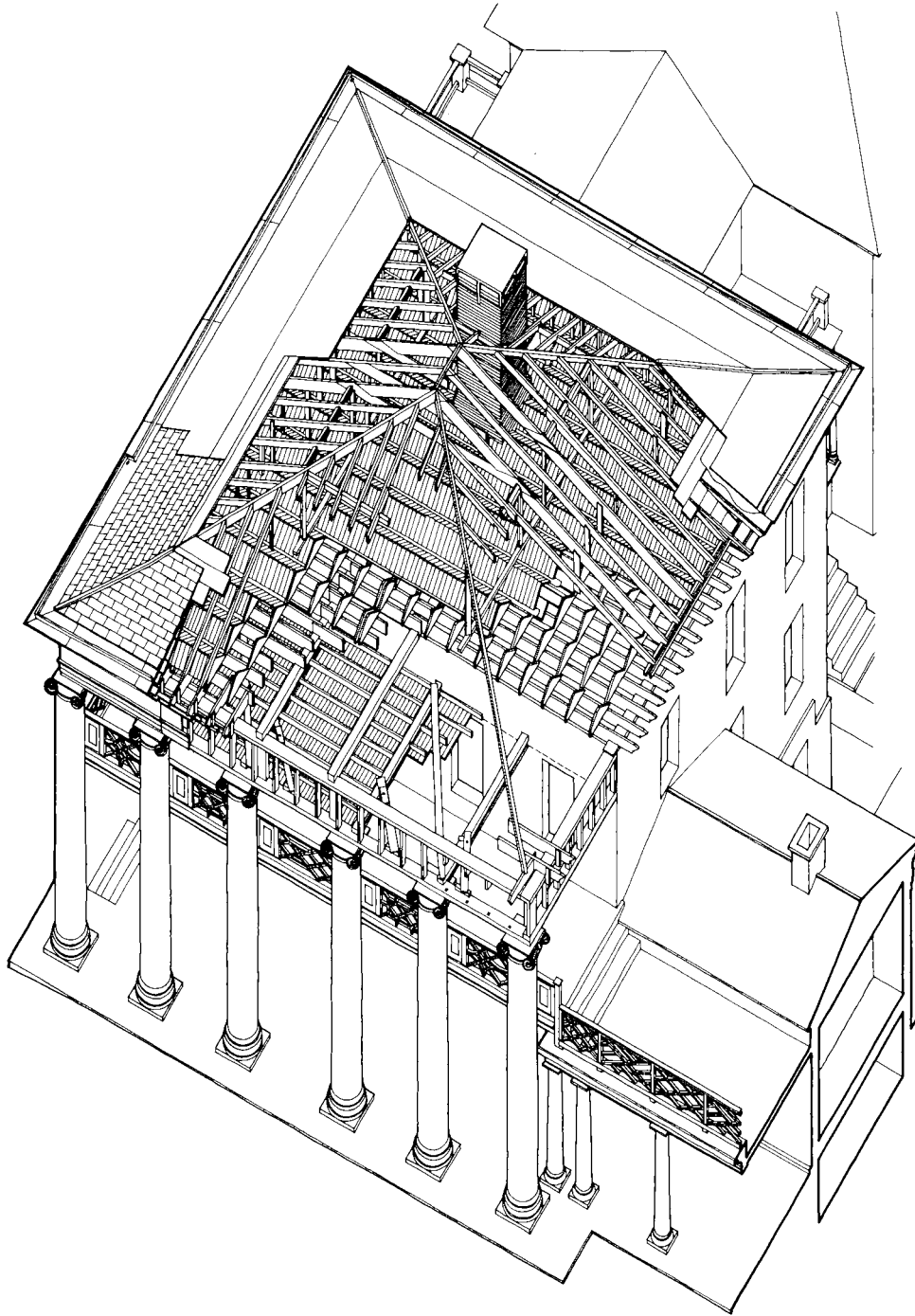

Axonometric drawing of roof framing

PAVILION V



Pavilion V, circa 1930